

SG1A

Approved For Release 2000/08/08 : CIA-RDP96-00789R003100280001-7

Approved For Release 2000/08/08 : CIA-RDP96-00789R003100280001-7

Reactions of the Central Nervous System to Peripheral

Effects of Low-Intensity EHF Emission

Natalia N. Lebedeva

Institute of Higher Nervous Activity and Neurophysiology
of the USSR Academy of Sciences

Abstract

The study of reactions of human CNS to peripheral effects of EHF emission, created by therapeutic apparatus Yav-I (the wave length is 7.1 mm) revealed restructuring of the space-time organization of biopotentials of the brain cortex of a healthy individual which indicate development of a non-specific activation reaction in the cortex. The study of sensory indication of EHF field with these parameters showed that it is can be reliably detected at the sensory level by 80% of the subjects.

Introduction

In the process of study of reactions of living systems with a different level of organization to millimeter waves, non-thermal (informational) effects were discovered [1-3]. The distance from the place affected by the emission to the location of appearance of the biological reaction may be hundreds and thousands times larger than the distance at which the emission decreases one order of magnitude. This fact demonstrates participation of the nervous system in perception of millimeter-range emission by living organisms.

There is a wide-spread opinion that biological effects of EMF are realized in humans at a subsensory level. However, in the recent years there is interest to their sensory detection in the

form of radiosound, magnetophosphenes, or skin sensations [4-9].

Changes in EEG to EMF effects were most often observed in the form of an increase in the slow waves and spindle-shape oscillations in reptiles, pigeons, rats, rabbits, monkeys, and humans [10-12].

We have not found studies devoted specifically to the effects of millimeter waves on the central nervous system in the available literature; thus, the current study has been undertaken. This study employed electrophysiological and psychophysiological methods for the evaluation of the state of the central nervous system while affected by EMF.

Methodology

Twenty healthy subjects aged 17 to 40 years participated in the experiments. Apparatus Yav-I with the wave length of 7.1 mm was used as the EMF source. A flexible waveguide with the power of 5 mW/cm² at its end was directed at He-Gu [4 Gi] acupuncture point in the right or left hand of the subject.

Two experimental series have been conducted. In the first one (10 subjects, 10 tests with each subject, 20 instances of field action in each test), sensory detection of the field was studied. The length of the EMF signal or control trial without the signal was 1 minute. To evaluate the subject's EMF sensitivity, the indicator of response strength (RS) was used, i.e., the ratio between the number of correctly identified trials and the total number of EMF signals. Another indicator used was the level of false alarms (FA), i.e., the ratio between the number of false

positives to the total number of control trials. The significance of the difference between RS and FA was evaluated by using the Mann-Whitney test. The analysis of latent time (T_{lat}) included total histograms of true responses and false alarms.

In the second series (10 subjects, 11 tests with each, including placebo tests) the exposure to the field was equal to 60 minutes.

EEG recording was conducted before and after the EMF influence by using EEG-16S (Hungary), with 4 paired leads, located according to 10-20% system (in the frontal F-F, central C-C, parietal P-P and occipital O-O areas). As the reference electrode, a joint ear electrode was used.

Together with EEG recording on paper, the data were fed for on-line processing into an IBM-PC Amstrad computer using spectrum coherent analysis by means of rapid Fourier transformations with plotting power spectra and computing mean coherence levels. Selected for the study were frequencies from 2 to 30 Hz in major physiological ranges of the EEG spectrum.

Results and discussion

In the first experimental series, the subjects showed a division into two unequal subgroups according to their RS and FA indicators. The first subgroup (8 individuals) could reliably [at a statistically significant level] detect EMF: the differences between RS and FA were significant according to Mann-Whitney test, the means for RS and FA being $64.3\% \pm 10.5\%$ and $20.6\% \pm 11.2\%$, respectively. The second subgroup (2 individuals) could not reliably

Approved For Release 2000/08/08 : CIA-RDP96-00789R003100280001-7
distinguish between EMF effects and control trials, the means for RS and FA being $59.0\% \pm 14.25\%$ and $43.53\% \pm 16.5\%$, respectively.

From the eight individuals who could detect the EMF well, two could reliably distinguish it from control trials with both hands, one could do this only with the left hand and the others only with the right hand. An analysis of distribution of T_{lat} of true responses and false alarms showed single mode distribution in both instances. The mean of latent time for eight subjects was 46.1 ± 5.8 sec.

The prevalent sensations were pressure (46.7%), tingling (36.3%), itching (8.9%), warmth-coolness (5.3%), and other sensations (2.8%). All the sensations were experienced either in the palm of the hand or in the fingers, each subject having his own set of sensations.

An analysis of the data obtained experimentally justifies the assumption that humans are capable to perceive sensorially the EFM in the millimeter range, similarly to their capacity of perceiving the ELF fields [4-6], which is in accordance with the results obtained elsewhere [9].

Interaction of any physical factor with biological systems of complex organization begins on their surface, and the skin is the first receptor. Unlike other analyzers, the skin does not have absolutely specific receptors. This was confirmed in experiments conducted by A.N. Leontiev and his associates [13], who conducted similar studies with non-thermal emission in the visible range of spectrum and found that their subjects were capable of reliably

Approved For Release 2000/08/08 : CIA-RDP96-00789R003100280001-7 -
distinguishing the emission effects from control trials. The modes
of perception were similar to those observed in our tests. Thus,
our results as well as data of other authors indicate the
importance of the skin analyzer in EMF perception.

Study of the modes of perception which occur in the process of
EHF field reception makes it possible to assume that EMF stimuli
are perceived either by mechanical receptors (sensations of touch
or pressure), or by pain receptors, i.e., nociceptors (tingling and
burning sensations). From mechanical receptors, only Ruffini's and
Merkel's endings and tactile disks may be involved in the process,
according to the depth of their location in the epidermis, their
adaptation speed and their capacity to spontaneous activity. The
assumption that nociceptors may be responsible for the reception of
EMF signal is based on the following: their polyspecificity in
relation to stimuli; the kind of sensations, i.e., tingling and
burning, which are considered precursors of pain; experiments which
showed complete disappearance of EMF sensitivity in individuals
whose skin at the place of influence was treated by ethyl chloride
that turns off pain receptors; facts from medical practice that the
EHF influence on the respective dermatome [dermatome means the
areas of the skin supplied with sensory fibers from a single spinal
nerve--LF] causes sensory response in the afflicted organ of the
body which may be the result of convergence of nociceptive
afferents from the dermatomes and the internal organs on the same
neurons of pain pathways. With this, skin hypersensitivity occurs
because visceral impulses increase the excitability of inter-

The latent time of EMF responses (to both ELF range and millimeter range EMF) is unusually large. While the reaction time of visual and auditory sensory systems is from dozens to hundreds of milliseconds, the perception of EMF takes dozens of seconds. This is in a good agreement with theoretical calculations by I.V. Rodshtat [14] who made an assumption that a single time cycle of microwave sensory reception, including detection of sensory sensation, is within 40 to 60 seconds. This is explained [according to him] by a complex structure of the reflex arc which includes both nervous and humoral links.

An analysis of inter-central EEG ratios is one of the approaches to the study of regulation mechanisms of functional states of the human brain.

As known from the literature [15], the indicator of coherence level (COHm) is the most significant of EEG correlates which characterizes the peculiarities of the human brain functioning.

Major changes of the cortical EEG with regard to both inter-central and intra-hemispheric connections in placebo tests can be characterized either by a decrease in COHm, especially in the range of delta and theta, or by maintaining the background level. A power spectrum analysis shows a decrease in the brain waves magnitude, especially in the alpha range (Fig. 1).

Thus, as a result of placebo (control) tests, a kind of "expectancy reaction" with specific space-time organization of the cortex biopotentials takes place.

A different EEG pattern is observed after the individual is exposed to EMF. There is a significant power increase in the alpha range, especially in occipital and parietal areas in both hemispheres; in other parts of the spectrum the power remains close to the background level (arrows 2 and 3 in Fig. 1). Unlike in placebo tests, an increase in the mean of the coherence level COHm takes place practically in all the subjects resulting from exposure to EHF. It mainly occurs in the frontal and central areas of the cortex and is mostly expressed in slow wave spectrum range (delta and theta). A similar pattern of brain waves is characteristic of the state of an increased brain tone, i.e., it occurs in non-specific activation reaction [16]. This kind of response is characteristic because it is known that frontal areas of the cortex are sensitive to various external factors. These zones have broad bilateral connections with other cortical and subcortical structures which determine the involvement of frontal areas in many functional response systems.

Conclusions

1. Peripheral effects of EHF (7.1 mm wave length, 5 mW/cm²) with a 60 minute exposure causes restructuring of the cortical brain waves in a healthy individual; this points to the developments of a non-specific activation reaction, i.e., to an increase in the tone of the cortex.

2. The study of sensory detection of EMF in EHF range showed that the field with the above parameters is detected at a statistically significant level by 80% of the subjects.

References

1. Devytakov, N.D., Betsky, O.V., Gelvich, E.A., et al. Radiobiologiya, 1981, Vol. 21, 2, pp. 163-171.
2. Devyatkov, N.D., Golant, M.B., & Tager, A.C. Biofizika, 1983, Vol. 28, No. 5, pp. 895-896 [English translation: Role of synchronization in the impact of weak electromagnetic signals in the millimeter wave range on living organisms. Biophysics, 28 (5), 952-954].
3. Sevastiyanova, L.A., Potapov, S.A., Adamenko, V.G., & Vilenskaya, R.L. Nauchnyye Doklady Vysseye Shkoly, 1969, Vol. 39, No. 2, pp. 215-220.
4. Lebedeva, N.N., Vekhov, A.V., & Bazhenova, S.I. In: Problemy elektromagnitnoy neurofiziologii [Problems of Electromagnetic Neurophysiology]. Moscow: Nauka, 1988, pp. 85-93.
5. Lebedeva, N.N., & Kholodov, Yu.A. Materials of the 15th Congress of I.P. Pavlov All-Union Physiological Society.
6. Kholodov, Yu.A. In: Materials of the 7th All-Union Conference on Neurophysiology. Kaunas, 1976, p. 395.
7. Andreyev, Ye.A., Bely, M.I., & Sitko, S.P. Vestnik AN SSSR, 1985, No. 4, pp. 24-32.
8. Lovsund, P., Oberg, P.A., & Nilsson, S.F.G. Med. Biol. Eng. Comput., 1980, Vol. 18, No. 6, pp. 758-764.
9. Kholodov, Yu.A., & Temnov, A.A. Materials of the 5th All-Union Seminar "Study of the Mechanisms of Non-Thermal Effects of EMF on Biological Systems." Moscow, 1983, p. 8.
10. Anderson, L.Ye. XXIII General Assembly of URSI, Prague, 1990, p. 12.
11. Semm, P. Comp. Biochem. Physiol., 1983, Vol. 76, No. 4, pp. 683-690.
12. Kholodov, Yu.A. Reaktsii nervnoy sistemy na elektromagnitnyye polya [Reactions of the Nervous System to Electromagnetic Fields]. Moscow: Nauka, 1975, 208 pp.
13. Leontiyev, A.N. Problemy razvitiya psikhiki [Problems of the Development of the Psyche]. Moscow: Moscow University Press, 1981, 582 pp.
14. Rodshtat, I.V. Preprint No. 20 (438). Moscow: Institute for Radio Engineering and Electronics of the USSR Academy of Sciences, 1985, 4, pp. 24-32.

15. Livanov, M.N. Prostranstvenno-vremennaya organizatsiya potentsialov i sistemnaya deyatelnost golovnogo mozga [Spatial and Temporal Organization of Biopotentials and Systemic Activity of the Brain]. Moscow: Nauka, 1989, 398 pp.

16. Sviderskaya, N.Ye. Sinkhronnaya elektricheskaya aktivnost mozga i psikhicheskiye protsessy [Synchronous Electrical Activity of the Brain and Mental Processes]. Moscow: Nauka, 1987, 154 pp.

восприя-
М-стиму-
ения,
ия по-
этом
и так-
скорос-
жение о
гнала
нию к
которые
вшие
работке
ые ре-
КВЧ-
икает
ии но-
нов на
ает
е им-
никает

том, характеризующим особенность функционирования мозга чело-
века.
Основные перестройки корковой ритмики как по межцентраль-
ным, так и по внутрислоушарным связям в опытах с плацебо мож-
но охарактеризовать следующим образом: либо это снижение
КОГср., особенно в области дельта-, тета-диапазонов, либо
сохранение фонового уровня. Анализ спектров мощности показы-
вает, что происходит снижение мощности ритмов биопотенциалов
мозга, особенно выраженное в альфа-диапазоне (см.рис.).

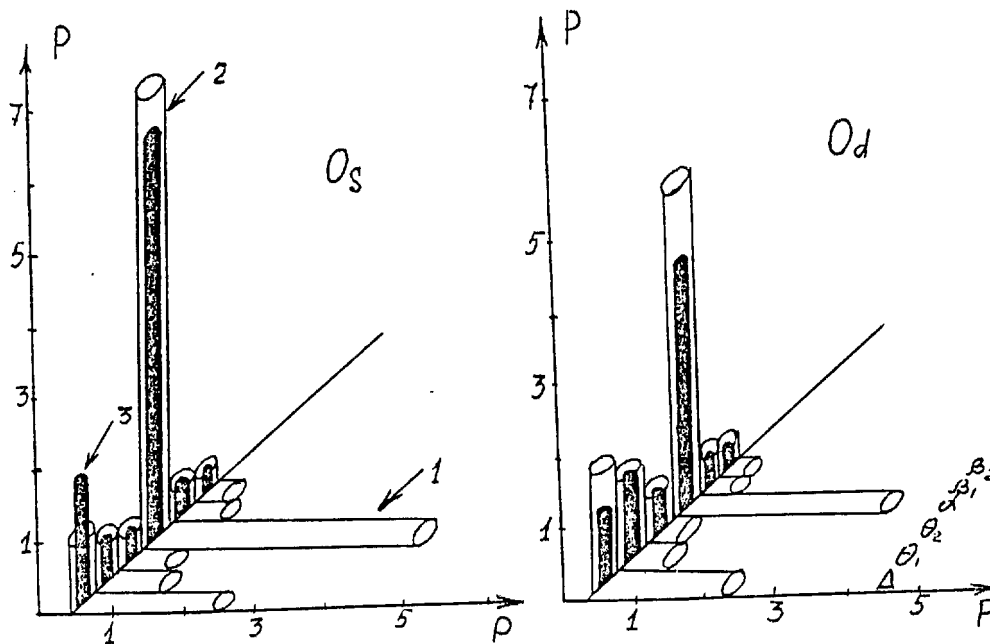

Fig. 1.

иапазо-
эри-
сотни
хорошо
I47,
энсор-
дущения,
ием
ное

Таким образом, в результате опытов с плацебо возникает
состояние своеобразной "реакции ожидания" с особой простран-
ственно-временной организацией биопотенциалов коры головного
мозга.

Из под-
ых сос-
т ко-
реля-

Иная картина наблюдается в ЭЭГ после экспозиции ЭМП. В
спектральном составе отмечается значительное повышение мощ-
ности в альфа-диапазоне, особенно в затылочных и теменных
областях обоих полушарий, в других диапазонах спектры мощ-
ности остаются близкими к фоновым (стрелки 2,3). В отличие от
опытов с плацебо в результате воздействия поля КВЧ практиче-
ски у всех испытуемых происходит повышение среднего уровня

TAB

BIOPHYSICS OF COMPLEX SYSTEMS

**RESONANCE EFFECT OF COHERENT
ELECTROMAGNETIC RADIATIONS IN THE
MILLIMETRE RANGE OF WAVES ON LIVING
ORGANISMS***

M. B. GOLANT

(Received 10 June 1987)

The results of Soviet and foreign theoretical studies furthering understanding of the mechanism of the acute resonance action of extremely high-frequency coherent electromagnetic radiations of low power on live organisms and the significance of these radiations for the functioning of the latter are analysed.

REFERENCE [1] presents a systematic review of experimental work promoting understanding of the mechanism of the acute resonance effect of extremely high frequency (e.h.f.)[†] low power irradiations on living organisms. The results of these studies show, in particular, that the cells of live organisms generate coherent acousto-electric vibrations of the e.h.f. range used in the body as control signals of its functioning. As follows from experimental research, the influence of the external e.h.f. radiations on the body is apparently connected with the fact that at certain resonance frequencies the signals coming from without imitate the control signals generated to maintain homeostasis by the body itself. External radiations may make good the inadequacy of the functioning of the control system of the body in conditions when the formation by it of signals of these frequencies is arrested or becomes less efficient for one or other reason.

Acquaintance with the data outlined in reference [1] greatly simplifies the review of theoretical work allowing one not to deal with the investigations in which the initial premise is the assumption of the impossibility of generation by live organisms of coherent vibrations.[‡] It also becomes possible to reduce to the limit the exposition of the essence of the first theoretical studies seeking to prove the possibility, in principle, of the mechanism of generation of coherent e.h.f. vibrations in living organisms but not tying the mechanisms considered to the features of their functional use: in such a complex system as the living body one may imagine a number of different mechanisms of genera-

* Biofizika 34: No. 6, 1004-1014, 1989.

[†] The frequency range corresponding to the millimetre range of wavelengths according to Soviet standard GOST 24375-80 is called the extremely high frequency range.

[‡] See reference [2] to acquaint oneself with the conclusions of such theories and the resulting insurmountable difficulties of squaring their conclusions with the results of experiments.

tion [3] but one may select the functional role.

Since the present review here remains outside its reference [4] although describing them in a very general form of control.

At the same time, a critical notion is required. The notion does not allow to conclusions significant experiments to elucidate unchanged as compared with which, as is known, is the results of the action of the adaptability of the organism.

Link between the effective controlling signals. Living organisms are a very developed system of systems as the mammalia (cells) but confines oneself to a variety indirectly characterized by the author of reference [7], (F of all types of form and

The field of effective ultraviolet frequency range of the coherent partially matching ideas of the control of processes in the organism must exist, i.e. in the volume necessary for the formation of systems to maintain homeostasis in an organism of information must be excited in a particular length. Consequently, to ensure the excitation of the excited waves must be the possible degree of the vibrations f is limited by the frequency is sufficient for the effective ultraviolet frequency range

But the wavelength in the organism by the velocity of propagation

0006-3509/89
© 1991 Pergamon

STEMS
RENT
S IN THE
N LIVING

standing of the mechanism of coherent electromagnetic radiations for the functioning of the mechanism promoting extremely high frequency of these studies show acousto-electric vibrations functioning. As for h.f. radiations on the resonance frequencies the adequacy of the functioning by it of one or other reason. This simplifies the review in which the initial exposition of the mechanism, in principle, of the organisms but not tying in such a complex mechanism of generation according to Soviet theories and the resulting experiments.

tion [3] but one may select those actually existing only starting from their correspondence to the functional role.

Since the present review is concerned with the biophysical aspects of the problem there remains outside its scope a wide range of biocybernetic studies (see, for example, reference [4]) although devoted to the control systems of living organisms but considering them in a very generalized form difficult to tie to analysis of the specific mechanisms of control.

At the same time, a review of theoretical work necessary for the formation of theoretical notions is required not only for the completeness of the picture: absence of theoretical notions does not allow one to stage correctly experimental investigations leading to conclusions significant in practice. For example, one widespread error is the use for experiments to elucidate the influence of e.h.f. radiations of organisms with a character unchanged as compared with normal of the ongoing functioning (the ongoing functioning of which, as is known, is not influenced by e.h.f. radiations [5]) and also evaluation of the results of the action of e.h.f. radiation disregarding the parameters characterizing the adaptability of the organism to particular conditions of existence [6].

Link between the efficiency of the control system and the frequency range of the controlling signals. Living organisms are exceptionally complex and accordingly require a very developed system of control. Even if one does not consider such ultracomplex systems as the mammalian organism or the human body (the latter includes 10^{14} - 10^{15} cells) but confines oneself to a single cell, its reactions are extremely varied and this variety indirectly characterizes the complexity of the system controlling them. Thus, the author of reference [7, (Russian translation)] writes: "...that to give a full description of all types of form and movement of eukaryote cells one book would not suffice".

The field of effective use of a particular control system is largely determined by the frequency range of the control signal. This problem was analysed in reference [8] and partially matching ideas are contained in reference [9]. Where the question concerns the control of processes in a single isolated cell the possibility of "writing" in its volume must exist, i.e. in the volume the mean size of which $\sim 10^{-16} \text{ m}^3$, any information necessary for the formation of signals exercising adequate control of the processes helping to maintain homeostasis in any conditions of the vital activity encountered, i.e. "the writing" of information must be extremely economical. The number of different signals which may be excited in a particular resonance system is primarily determined by its electrical length. Consequently, to ensure the necessary diversity of the control signals the lengths of the excited waves must be very short as compared with its geometric length. Naturally, the possible degree of the contraction of wavelength by increasing the frequency of the vibrations f is limited by the fact that beyond a certain limit the energy of the quantum hf is sufficient for the effective destruction of biological bonds, i.e. is actually limited by the ultraviolet frequency range.

But the wavelength in the system λ is determined not only by the frequency but also by the velocity of propagation v :

$$\lambda = v/f. \tag{1}$$

If the magnitude v corresponds to the velocity of propagation of acoustic waves (hundreds of m/sec) then at frequencies equal to or exceeding 10 GHz the λ values become less than 10^{-8} m which ensures the possibility of accommodation in the cell volume (the mean linear size of which $\sim 10^{-5}$ m) of resonance systems of large electric length. The velocity in hundreds of m/sec is peculiar not only to purely acoustic waves but also to acousto-electric waves which will be considered below. Further substantial (by 1-2 orders of magnitude) contraction of the wavelength would lead to its commensurability with the size of the atoms a consequence of which would inevitably be the thermal instability of any informational structures the size of the informationally significant elements of which would be of the order of one wavelength. The contraction of λ to the same values for smaller f through further fall in v would lead to mechanical instability of the wave-guide structures (cell membranes [1]) as a result of decrease in the elastic modulus (see below).

The ideas presented make it clear why the influence of coherent radiations of low (non-thermal) intensity on live organisms has been particularly often observed in the millimetre* and even shorter wave ranges. As shown in reference [8] in terms of use in the information system of living organisms the millimetre waves possess two further advantages.

1. The energy losses associated with the propagation in lipid membranes of an electric e.h.f. field are relatively low (in the longwave part of the millimetre range ~ 0.25 dB/cm [10]). From the data of reference [1] it is clear why the water surroundings of the lipid membranes do not influence the size of these losses: the aqueous medium is separated from the hydrophobic layer by a space ~ 10 Å in which the density of the flux of e.h.f. power falls by an order. Apparently (judging from the width of the resonance bands given in reference [1]) the acoustic losses are also low which is also probably explained by the feature already noted in reference [1] of the structure of the membranes: the acoustic link through the 10 Å-slit separating the hydrophobic layer from the cytoplasm is greatly weakened.

2. The energy expenditure on the formation of a certain volume of information in the millimetre range is relatively low as compared both with the longer wave and the far shorter wave ranges. This is connected with the difference in the character of noise in these ranges as compared with the millimetre. In longer wave ranges noise of a thermal nature dominates.

Since in this region $hf \leq kT$, the information signals, the intensity of which exceeds or is commensurate with the noise level, are formed by a very large number of quanta. The information content of such signals rises with the frequency f . But since the necessary level of signals is determined by the magnitude kT the ratio of the volume of information to energy expenditure on its formation rises with f .

In the far shorter wave region $hf \geq kT$. Here the quantum noise associated with the discrete nature of the radiation dominates. Reliable transfer of a certain volume of information requires that the corresponding signal is formed by the number of quanta

* We would recall that the millimetre range of waves corresponds to the frequencies of the vibrations of 30-300 GHz - e.h.f. frequency range.

ceeding a certain l
minimal the energy c
the ratio of the volur
region where $hf \gg kT$
energy resources mir
the millimetre and
Acousto-electric e
ives the results of ex
the cells is connected
anes. A theoretical a
on the basis of the da
 ≈ 0.45 N/m, thickr
ven of the velocity c

where ρ is the density
equal to 800 kg/m^3 . Th
(2) may one may calcu
frequency shift between
ing to change per unit
the membrane: *

where d is the diameter
The Δf values calcu
spectral characteristics
preceding section that th
acoustic waves. Separati
(3) to the form

since the number N of
equal for the cells in w
hundreds or thousands ther
biological membranes c
 10^3-10^4 .

As is known [3], cell
cell strength of the
 10^7 V/m. Therefore, or
membrane thickness) in
field changing with the fr

* Although excitation o
erent d , this is of no importa
values corresponding to differ

exceeding a certain level minimal for this volume of information. The higher f the more minimal the energy of the signal determined by the given number of quanta. Therefore, the ratio of the volume of information to the energy expenditure on its formation in the region where $hf \gg kT$ falls in proportion to f . For living organisms with their limited energy resources minimization of the expenditure of the latter determined by the use of the millimetre and shorter wave ranges nearest to it is quite substantial.

Acousto-electric e.h.f. waves in cell membranes and their resonances. Reference [1] gives the results of experiments showing that the resonance effect of e.h.f. radiations on the cells is connected with excitation of the acoustic-electric waves in closed cell membranes. A theoretical analysis of the problem is outlined in references [5, 11]. In this work on the basis of the data on cell membranes presented in reference [12] (elastic modulus $K_e \approx 0.45$ N/m, thickness of the hydrophobic region $\Delta_m \approx 3 \times 10^{-9}$ m) an evaluation is given of the velocity of propagation of acoustic waves in the membrane:

$$v_p \approx (K_e / \rho \Delta_m)^{0.5}, \quad (2)$$

where ρ is the density of the lipid (fat-like) layer which for the calculation is taken as equal to 800 kg/m^3 . The magnitude v_p calculated from (2) is $\sim 400 \text{ m/sec}$. Using (1) and (2) one may calculate the wavelength in the membrane for different f and also the frequency shift between the centres of the neighbouring resonance bands Δf corresponding to change per unit of the number of wavelengths accommodated at the perimeter of the membrane:*

$$|\Delta f| \approx (K_e / \rho \Delta_m)^{0.5} (\pi d)^{-1}, \quad (3)$$

where d is the diameter of the membrane.

The Δf values calculated from (3) satisfactorily agree with those presented for the spectral characteristics of different cells [1]. This confirmed the ideas discussed in the preceding section that the information signals in the cells must spread at the speed of the acoustic waves. Separating the right and left parts of (3) into f and using (1) we transform (3) to the form

$$f / \Delta f = \pi d / \lambda. \quad (4)$$

Since the number N of wavelengths λ at the perimeter of the membrane equal to $\pi d / \lambda$ is equal for the cells in which the value d lies within the limits $0.5-10 \mu\text{m}$ to several hundreds or thousands then relation (4) indicates that the sharpness of the resonances in biological membranes corresponds to that of the contours with the quality factor $\sim 10^3-10^4$.

As is known [3], cell membranes are polarized and during normal functioning of the cell the strength of the electric field in the membrane perpendicular to its surface is $\sim 10^7 \text{ V/m}$. Therefore, on propagation of acoustic waves (producing periodic changes in membrane thickness) in the polarized membrane there appears an alternating electric field changing with the frequency of the acoustic vibrations exciting it. For vibrations of

* Although excitation of the vibrations may occur in membrane sections corresponding to different d , this is of no importance in evaluating the magnitudes since as a rule the differences in the d values corresponding to different sections are insignificant.

low amplitude considered here the membrane represents a linear system and hence for a certain size of the constant electric field in the membrane the ratio of the amplitudes of the acoustic and electric vibrations remains constant regardless of the amplitude of the spreading wave, i.e. an acoustic-electric wave is considered in which the variable electrical and acoustic parameters cannot be regulated independently.

It should be noted that unlike electromagnetic waves (the slowing of which in the membrane would be insignificant) the length of the acoustic-electric wave in the membrane is $\sim 10^4$ times less than the wavelength in free space and, therefore, the energy of the electric e.h.f. field in the course of the vibrations in the main is transformed not to the energy of the magnetic field but to the energy of the acoustic e.h.f. vibrations and back. This is similar to the transformation of energy in some low frequency parametric systems in which the vibrations are maintained through transformation of the mechanical energy expended on increasing the distance between the charges on the condenser plates to the energy of the electric field.

To the different resonance frequencies f corresponds a different number of standing waves at the perimeter of the membrane. Therefore, the character of the distribution of the e.h.f. field also changes with f both at the surface of the membrane and in the intra- and extra-cellular spaces lying next to it and, consequently, so does the character of the controlling action of the e.h.f. field. But for a large total number of wavelengths accommodated at the perimeter of the membrane, change in this number per unit corresponding to the neighbouring resonances introduces a slight change in the character of the field distributions. As a result the character of the controlling action connected with the spatial structure of the field gradually changes from one resonance to another. At the same time the controlling action of the external radiations may be connected not only with the spatial field distribution but with the resonance frequencies of particular protein molecules or intracellular elements. These last changes are more weakly connected with the structure of the field of the acoustic-electric waves. In reference [5] it is also noted that since different membrane systems literally pierce the whole cell the acoustic-electric waves branching off from the resonating membrane may penetrate to any region of the cell, the direction of propagation and action depending on the type of vibrations in the resonating membrane and the character of the membrane network changing configuration in different conditions [7].

The theoretical evaluations and ideas presented above applying both to acoustic-electric waves and their controlling action in the cells did not touch upon the problems of excitation of such waves. The question of excitation is trivial neither for the case when it operates under the influence of external radiation nor the autonomous generation of vibrations by the cell itself. Discussion of the problems connected with the excitation of vibrations in the membrane directly leads to analysis of the mechanism of generation by the cells of coherent vibrations. Therefore, it appears desirable before starting such a discussion to go briefly into some hypotheses on the character and nature of the mechanism of action of coherent vibrations on living cells put forward even before clarification of their functional role in living organisms and the careful experimental treatment of the problems associated with these mechanisms.

R
 first theoretical n
 ong the theoretic
 of coherent vibr
 which already beg
 the first to express
 holic energy coh
 vibrations possib
 ng the thickness
 that the action
 stic vibrations wi
 lectric vibrations i
 röhlich came to t
 e. All these and a
 retain their value
 anisms of genera
 e radiations. He p
 is similar to the v
 excitation. Therefor
 ough to initiate gene
 tion.
 The vibrations acc
 olarization waves i
 reservoir and are
 al systems with lo
 for phenomena of
 distribution of ener
 ow frequency forms
 ed conformational
 a mechanism of ge
 hypothesis the role
 ce also its need for
 ously assume that
 uency range discuss
 accordingly, in wor
 tion of organisms t
 eviation from norm
 variety of the spect
 ed; nor were questio
 e signals generated
 study of the probl
 tical use of e.h.f. ir
 How far the hypoth
 clear. Probably it is

First theoretical models of the mechanisms of excitation of coherent vibrations in cells.

Among the theoretical studies aimed at validating the possibility of generation by living cells of coherent vibrations a special place is taken by the numerous investigations by Fröhlich already begun in 1968 and summarized by him in 1980 [13]. Fröhlich was one of the first to express the conviction that in living organisms thanks to the presence of metabolic energy coherent vibrations may be generated with the energy of random thermal vibrations possibly being transformed to the energy of coherent vibrations. Comparing the thickness of the membrane with the length of the acoustic waves he postulated that the action of radiation may be the cause of excitation in the membranes of acoustic vibrations with which following polarization of the membranes the appearance of electric vibrations is connected.

Fröhlich came to the conclusion that the resonance frequencies may lie in the e.h.f. range. All these and a number of other ideas, in somewhat modified and refined form, still retain their value today. Fröhlich theoretically also worked out one of the possible mechanisms of generation of vibrations by the cells on exposure to external electromagnetic radiations. He postulated that the mechanism of generation of vibrations by the cells is similar to the work of a regenerative amplifier brought to the face of the regime of excitation. Therefore, a very low external signal (he did not discuss other cases) is enough to initiate generation of coherent vibrations the power of which approaches saturation.

The vibrations according to Fröhlich [34] are connected with the strong interaction of polarization waves in a certain band lying in the frequency region $\sim 10^{11}$ Hz, with a heat reservoir and are ensured by the inflow of energy from metabolic sources. In biological systems with low frequency collective vibrations favourable conditions are created for phenomena of the Bose-Einstein condensation type in the course of which there is redistribution of energy between the different degrees of freedom and the concentration in low frequency forms of vibrations. Condensation determines the possibility of goal-directed conformational conversion. Fröhlich was unable to demonstrate the presence of such a mechanism of generation (see below). Moreover, in the period when he advanced the hypothesis the role of coherent e.h.f. vibrations for the functioning of the cell and hence also its need for them was not known. Only in one of his late papers [14] did he cautiously assume that biological systems "...themselves somehow use radiations in the frequency range discussed and are, therefore, sensitive to the corresponding radiations".

Accordingly, in working out the hypothesis questions connected with the different reaction of organisms to radiation as a function of the initial state of the organism and its deviation from normal were not raised or solved; nor were questions concerned with the variety of the spectra generalized by living organisms in particular cases raised or solved; nor were questions of the significance for the organisms of the degree of coherence of the signals generated raised or solved as is also true of a host of other problems underlying study of the problem today when answers to specific questions associated with the practical use of e.h.f. influence are required.

How far the hypothesis presented may be adapted to solve the questions arising is not clear. Probably it is simpler to validate the theoretical construction of the mechanisms

of action isolating oneself from model concepts corresponding to the results of experimental research. In this connexion of interest is the many years of discussion between H. Fröhlich and M. A. Livshits and other supporters of their views [15-18]. The point is that to describe the mechanism of excitation of coherent vibrations in the cell Fröhlich proposes [19] a kinetic equation including second order terms ("two-quantum" terms) characterizing the redistribution of energy between the different vibrations as a result of interaction with a thermostat. Livshits considers that "two-quantum" terms are not completely written in the Fröhlich equation. But if this omission is removed then the mechanism of excitation of coherent vibrations worked out by Fröhlich will not work.

Objecting to M. A. Livshits, H. Fröhlich writes that the "unusual physical properties of biological systems developed by long evolution cannot be predicted by simple model calculations but call for direct harmonization with the experiment". Can one choose between these two mutually exclusive views?

At first sight the experimental detection of generation by the cells of coherent vibrations [1] favours the correctness of Fröhlich's kinetic equation. But such a conclusion would be illogical: generation may not be connected with that mechanism which reflects this equation. But in such a case the subject of discussion would be peripheral to the real problem. The only way to isolate the true mechanism among the hypothetically possible is to establish its correspondence to the whole body of know facts (including the facts outlined above). Therefore, the view of the author of the review will be formulated below after ending the discussion of the published data.

Fröhlich's hypothesis was not the only approach to the problem; there are others stemming from the idea of the existence in living organisms of coherent vibrations but not solving the real problems listed above. Thus, for example, the author of reference [2] in 1984 advanced a hypothesis based on the assumption of the existence of a still unidentified molecule taking part in the intermediate stages of development of biochemical reactions and present in the triplet state in which two unpaired electrons interact with their magnetic fields. The molecule has three possible initial states to each of which corresponds its course of chemical reactions. It is assumed that the initial state may be influenced by e.h.f. pumping so regulating the course of the processes. Naturally, this hypothesis, too, cannot give concrete answers to the real problems of using e.h.f. signals in medicine and biology if only because of the unidentified nature of the molecules the existence of which is taken as its base.

Effect of external e.h.f. radiation on the process of excitation of acoustic electric vibrations in cells, character of the influence of external radiations on the functioning of the cells. In many experimental studies it is emphasized [1] that a single external e.h.f. exposure does not act on the ongoing functioning of healthy cells. In reference [5] it was shown that this may be due to the absence of a link between the retarded e.h.f. waves in the membrane and the unretarded or weakly retarded waves of external radiation. From electrodynamics it is known [20] that the link between delayed and undelayed waves may be established by one or more coupling elements (antennae, slits, etc.) located at points the vibrations in which occur approximately in the same phase, i.e. shifted relative to each other by a whole number of delayed waves. And, in fact, reference [1] presents published

data on the formation of disturbed (and extended) structures which may be destroyed. But how do these structures form? The component of the wave is shorter than the length of the membrane. The amplitude of the field on the membrane is determined by the exponential law. The action of the pump is such a rapidly changing field (where the aqueous medium is exposed to these waves) on the surface and adhere to the membrane. In fact, the process is determined not only by the frequency of the membrane pulsating in the square of the field strength. In terms of smallness the field is acting on the protein molecules. (2.1) where E_1 is the amplitude of the field; l is the ongoing length of the membrane. Consequently, the length of the retarded wave is much longer than the length of the membrane which in line with the foregoing is not optimally the link between the membrane and the field. From the photographs of the structures described for the membrane of curvature or in narrow channels of the fields where their interaction in many cases lead to deformation of these temporary structures. The cells with disturbed membranes on exposure to the field only of the linking elements. The formation of stable information structures also after arrest of irradiation. It should be noted that the structures described but not formed by such cell deformation. The response of the cells to repeated exposure to a single exposure cannot be explained. To conclude the exposure to the field and the external e.h.f. field

data on the formation at the membrane surface in periods when normal cell functioning is disturbed (and external radiation is capable of acting on its recovery) of temporary structures which may also act as coupling elements.

But how do these temporary structure form? Since the membrane for the electrical component of the waves excited in it is a retarding system the wave length in which λ is shorter than the length of the electromagnetic waves in the surrounding space, the amplitude of the field on moving from the surface of the membrane decreases approximately by the exponential law $\exp(-2\pi x/\lambda)$ where x is the distance from the surface [21]. The action of the polarization forces on the excited protein molecules (see below) in such a rapidly changing field, especially at the surface of the lipid layer of the membrane (where the aqueous medium does not penetrate), is always directed to the surface [22]. On exposure to these forces protein molecules and aggregates move to the membrane surface and adhere to it [1] from which the elements of the temporary structure are formed. In fact, the polarization forces acting on the molecules and aggregates are determined not only by the variable but also by the constant components of the field in the membrane pulsating in response to the acoustic wave. These forces are proportional to the square of the field strength. As shown by calculation, if one ignores second order terms of smallness the variable component depending on the coordinate l of the forces F_1 acting on the protein molecules at the membrane surface is proportional to $E_1 \sin^2(2\pi l/\lambda)$ where E_1 is the amplitude of the variable component of the wave field in the membrane; l is the ongoing coordinate read off along the perimeter of the excited section of the membrane. Consequently the F_1 maxima are shifted relative to each other by the length of the retarded wave λ (but not $\lambda/2$ as in the standing wave), i.e. by the distance which in line with the forgoing is necessary for the temporary structures formed to ensure optimally the link between the waves in the membrane and surrounding space.

From the photographs given in reference [23] it will be seen that the temporary structures described form not over the whole perimeter of the membrane but at points of curvature or in narrow gaps between the membranes, i.e. in regions of concentration of the fields where their amplitude is maximal. The factors disturbing cell functioning in many cases lead to deformation of the membranes which apparently causes the formation of these temporary structures. Therefore, the effect of the external e.h.f. signals on the cells with disturbed functioning grows. At the same time amplification of the field in the membrane on exposure to e.h.f. fields leads to acceleration of the formation not only of the linking elements of the cells with the external e.h.f. field but also to the formation of stable information structures ensuring generation by the cells of e.h.f. signals also after arrest of irradiation [1] (see also below).

It should be noted that strengthening of the link with the external field is also promoted by such cell deformations still not leading to the formation of the temporary structures described but such a link must be weaker. This probably determines the response of the cells to repeated exposure to external e.h.f. irradiation where the response to a single exposure cannot be detected [24].

To conclude the exposition of the question of the link between the cell membranes and the external e.h.f. field we would mention that the literature quoted in reference [1]

describes the possibility of enhancing this link by adding to the nutrient medium in which the cells are present long-fibre molecules in a concentration corresponding to their position close to the surface of the plasma membrane at distance λ from each other [5]. The nature of the attendant strengthening of the link is understandable from the foregoing remarks.

In reference [25] the authors discuss the nature and character of the influence of low intensity external e.h.f. radiation on the cells which is linked with synchronization by coherent low intensity radiations of the vibratory processes in the cell. With synchronization is linked the strengthening of these vibrations determined, in particular, by the coherent summing of the vibrations previously dephased or excited at different frequencies of the intracellular sources and the formation of a highly effective controlling signal capable of orienting in a definite way or reorienting the processes in the cells (see above).

Since ionic and molecular transport takes place across the membrane ensuring the vital activity of the cell and the membrane takes an active part in its regulation [3] in reference [25] it was assumed that external e.h.f. radiation must influence it.

It is important to emphasize that external e.h.f. radiation is not an energy source for the established coherent vibrations in the cells but merely synchronizes them. The question of the transformation of the random energy of metabolism to the energy of coherent vibrations demands special analysis. One of the later sections is concerned with this question.

Excitation of the vibrations of protein molecules in the cell. The published data outlined in reference [1] referring to experimental studies indicate that the living cell as an autonomous system is controlled by e.h.f. signals generated by the cell itself. A major role in this process is apparently played by the protein molecules. In the literature the problems of excitation of vibrations in protein molecules have been explored reasonably fully both experimentally and theoretically.

The most detailed experimental investigations [26-30] were undertaken under the direction of Didenko on a specially designed apparatus permitting use of spectra obtained by the method of nuclear gamma resonance spectroscopy. The apparatus permitted various measurements in conditions of e.h.f. irradiation both of crystalline and lyophilic haemoglobin samples including measurements in a strong magnetic field ensured by the use of superconducting solenoids with change in the temperature of the samples from room to helium. Haemoglobin was used as protein, although the results of measurement probably apply more generally. As shown by the measurements, e.h.f. exerts a resonance action on the haemoglobin molecules expressed in changes in the Mossbauer spectrum: the width of the resonance bands at room temperature is only 3 MHz. Several series of resonance bands were detected. From analysis of the changes in the Mossbauer spectra Didenko concluded that on e.h.f. irradiation the haemoglobin molecules pass to new conformational states distinguished by the distribution of charge of the electrons and by the electric field gradient on the iron nucleus; at resonance frequencies the tertiary structure is rearranged in the globin part of the molecule and its dynamic properties change.

These problems have also formed the subject of numerous theoretical investigations in the recent period. Among them we would note the work of Frauenfelder *et al.* [31-33]

who developed the
molecules perform
many of these state
res (nitrogen level
overcoming the pot
energy of the transit
equilibrium. The co
molecules of their bi
an averaged distrib
The e.h.f. signal is
onal states in those
synchronizing signal.
the electromagnet
molecules are distrib
pole moments [35]
ence [36] at differen
particularly effective i
the membranes wi
acoustic (see precedin
protein molecule. As i
les are drawn to the
ner surface of the m
a result informati
one of them was giver
Didenko relates th
in the Mossbauer spec
frequencies of acoustic
acoustic resonators Q_e
ogy with polymers is q
molecules the effects of
ing one to isolate the a
noise.

Mechanism of gene
previous sections allow
generation of e.h.f. vibr
readily noted the actio
imitates their autovibr
Probably it is ration
the autovibrations. In
g to anomalies in its f
citation are created in
this leads to synchroni
the membrane and the r

who developed the model of the dynamic behaviour of proteins according to which the molecules perform fluctuations passing from one conformational state to another, many of these states being energetically very close to each other. At reduced temperatures (nitrogen level and even lower) the probability of such transitions associated with overcoming the potential barriers falls in proportion to $\exp[-E_c/kT]$ where E_c is the energy of the transition [34]. At room temperature most of the substates are in thermal equilibrium. The conformational mobility is important for the fulfilment by the biomolecules of their biological function. Accordingly thermal equilibrium leads to a certain averaged distribution of these functions between the molecules.

The e.h.f. signal is capable of synchronizing the vibrations isolating certain conformational states in those molecules with resonance frequencies close to the frequency of the synchronizing signal. The possibility of excitation of the vibrations in protein molecules by the electromagnetic signal is determined by the fact that ions as part of the protein molecules are distributed in them unevenly so that these molecules have considerable dipole moments [35]. In line with the model of biomacromolecules developed in reference [36] at different frequencies the e.h.f. field interacts with their different portions. Particularly effective interaction of the e.h.f. field with protein molecules must occur close to the membranes where the e.h.f. waves are retarded and their lengths are equal to acoustic (see preceding section) the length of which is commensurate with the size of the protein molecule. As made clear above, on exposure to an e.h.f. signal the protein molecules are drawn to the membrane surface, the character of the process of drawing to the inner surface of the membrane being similar to that of molecules to its outer surface [23]. As a result information structures may form on the membrane surface (an example of one of them was given in reference [1]).

Didenko relates the results obtained by her in study of the action of an e.h.f. signal on the Mossbauer spectra of protein molecules to excitation in the latter at the resonance frequencies of acoustic vibrations. The quality factor of the haemoglobin molecules as acoustic resonators Q_{ev} according to the evaluation made by her (on the basis of the analogy with polymers is quite large: $\sim 10^4$). The magnitude $hfQ_{ev} \gg kT$ and, therefore, in such molecules the effects of accumulation of the energy of many quanta may operate allowing one to isolate the action of even very weak coherent signals against the background of noise.

Mechanism of generation by the cells of coherent e.h.f. signals. The material of the previous sections allows us to pass to an exposition of ideas on the mechanisms of auto-generation of e.h.f. vibrations in the cell [5]. This is a very important question since as already noted the action of the external signals on the cells is effective only to the extent it imitates their autovibrations.

Probably it is rational to outline as follows the sequence of the process of excitation of the autovibrations. In conditions when as a result of certain actions on the cell leading to anomalies in its functioning its symmetry is disturbed, conditions of preferential excitation are created in the cell membranes at certain resonance frequencies (see above). This leads to synchronization of the vibrations of those protein molecules adhering to the membrane and the resonance frequencies of which coincide or are close to the fre-

quencies mostly excited in the membranes. Synchronization and the associated coherent summing of the vibrations ensure rise in the efficiency of transfer of their energy to the membrane and radiation to the surrounding space. As a result the dependence of radiation on frequency begins to differ from that observed in the case of equilibrium thermal radiation at the temperature of the cell: at resonance frequencies it rises. Naturally, the rise in the energy of radiation occurs through the energy of metabolism compensating rise in the energy losses on radiation (but not through cooling of the cell).

Transformation of energy apparently occurs as follows. Disturbance of thermal equilibrium through increase in radiation at certain resonance frequencies leads to redistribution of energy between the protein molecules taking place during energy exchange between them and directed at restoring the equilibrium state. This process is linked with the preferential transfer of energy to the molecules synchronized by the vibrations of the membranes since the radiation at their resonance frequencies is more intense than that at the frequencies of the vibrations of other molecules. Maintenance of the temperature of the cell is ensured by fall in the removal of energy of metabolism into the external space.

In the initial period after disturbance of the symmetry of the cell giving rise to the generation of coherent vibrations, the number of protein molecules adhering to the membrane is relatively low as compared with the periods when protein molecules are drawn to the membranes from the cytoplasm (especially at those portions of the membrane surface which undergo the sharpest distortions [37]). With increase in the number of molecules adhering to the membrane and the formation of information structures the resonance become sharper, the energy transmitted by the protein molecules to the membrane and emitted into space (the energy of the coherent vibrations generated by the cells) grows.

The process of rise in the power of the coherent vibrations generated is not limitless. The limitations are connected with the non-linearity of the process. Wherein lies its source? In reference [1] attention was drawn to the fact that enlistment of protein molecules further from the surface to form information structures on the membranes requires energy expenditure exponentially growing with distance. This inevitably leads to restriction of the attainable power of the vibrations, i.e. to passage to steady generation. The higher the level of disturbances and the greater the invaginations of the membrane it produces [37] the higher the maximum level of the vibrations generated.

The reaction of the systems present in the state of stable equilibrium to the forces perturbing them (but not leading to irreversible changes) always boils down to fall in the effect of the action of the latter (le Chatelier principle; in relation to living organisms the same meaning is attached to the concept of homeostasis). In this case this means that the effect of the control e.h.f. signals generated by the cell always restores the stable state of the cell whatever the cause of its disturbance or to the greatest possible fall in the effects of the action of the forces is in disturbing the given state. * Detailed treatment of all the associated processes is not possible since the processes perturbing the work of the cell are highly diverse but, for example, elimination of the membrane deformations is easy

* The character of the processes is determined both by the spectrum of the signals generated and the localization of the disturbances producing them.

explain as a consequence of the interaction of the forces drawn to them by the vibrations of the membrane which for the correct operation of the cell must necessarily accelerate the process. The process described above has not been touched upon in the literature (see also references given). The mechanism of the process is not clear.

The process described above has not been touched upon in the literature (see also references given). The mechanism of the process is not clear.

- GOLANT, M. B., BILIMAN, F., Phys. Lett., 1982
 BYERGERSON, L. I., 1982
 HAKEN, H., Biol. Cybernetics, 1982
 GOLANT, M. B. and BYERGERSON, L. I., IEE
 FURIA, M. et al., IEE
 FULTON, A., Cytoskeleton, Mir, Moscow, 1987
 DEVYATKOV, N. D., J. Biochem. Physiol., 1982
 TASTED, J. B., J. Biochem. Physiol., 1982
 LAND, D. V., IEEE Proc., 1982
 GOLANT, M. B. and BYERGERSON, L. I., J. Biochem. Physiol. and Medicine (in Russian), 1982
 IVKOV, B. G. and BYERGERSON, L. I., J. Biochem. Physiol. (in Russian) p. 224, Nauchn. Zh. Vuzov, 1982
 FRÖHLICH, H., Adv. Phys., 1982, pp. 39-100
 Idem., Mol. Models of Information, 1982, pp. 39-100
 LIVSHITS, M. A., Biofizika, 1982, pp. 39-100
 FRÖHLICH, H., *Ibid.*, 1982, pp. 39-100
 WU, T. M. and AUSTIN, T. H., *Ibid.*, 1982, pp. 39-100
 YUSHINA, M. Ya., *Ibid.*, 1982, pp. 39-100
 FRÖHLICH, H., *Ibid.*, 1982, pp. 39-100
 LEBEDEV, I. V., Techn. Cybernetics, Moscow, 1972
 SILIN, R. A. and SAZONOV, V. I., Moscow, 1966
 POHL, H. A., Coherent Electronics, 1983
 SOTNIKOV, O. S., Dynamics of Living Systems, Leningrad, 1985
 GOLANT, M. B. et al., Eff. of High-Frequency Fields on Living Objects (in Russian) pp. 11
 DEVYATKOV, N. D. et al., Eff. of High-Frequency Fields on Living Objects (in Russian) pp. 63

to explain as a consequence of the impacts on their protruding portions of the molecules drawn to them by the e.h.f. field. The use of external e.h.f. signals of the same frequencies which for the corresponding disturbances would be generated by the organism itself may accelerate the process of generation of the information structure or make it more effective.

The process described is a system process involving metabolism, protein molecules and the membrane system alike and if one considers multicellular organisms (which we have not touched upon in the present review in order not to complicate the exposition) then one also considers the organism as a whole (naturally its different parts to differing degrees). The mechanism described, of course, is still highly hypothetical.

REFERENCES

1. GOLANT, M. B., *Biofizika* 34: 339, 1989
2. KEILMAN, F., *Physik in unserer Zeit*, No. 2, 33, 1985
3. BYERGERL'SON, L. D., *Membranes, Molecules, Cells* (in Russian) 183 pp., Nauka, Moscow, 1982
4. HAKEN, H., *Biol. Cybern.* 56: 11, 1987
5. GOLANT, M. B. and REBROVA, T. B., *Radioelektronika*, No. 10, 10, 1986
6. FURIA, M. *et al.*, *IEEE Trans. Biomed. Engng.*, Vol. BME-33, p. 993, 1986
7. FULTON, A., *Cytoskeleton. Architecture and Choreography of the Cell* (in Russian) 117 pp., Mir, Moscow, 1987
8. DEVYATKOV, N. D. and GOLANT, M. B., *Pis'ma v ZhTF* 12: 288, 1986
9. TASTED, J. B., *J. Bioelect.* 4: 367, 1985
10. LAND, D. V., *IEEE Proc.* 134: 193, 1987
11. GOLANT, M. B. and SHASHLOV, V. A., *Use of Millimetre Low Intensity Radiation in Biology and Medicine* (in Russian) pp. 127-131, IRE, Akad. Nauk SSSR, Moscow, 1986
12. IVKOV, B. G. and BYERESTOVSKII, G. N., *The Lipid Bilayer of Biological Membranes* (in Russian) p. 224, Nauka, Moscow, 1982
13. FRÖHLICH, H., *Adv. Electronics and Electron. Phys.* 53: 85, 1980
14. *Idem.*, *Mol. Models of Photoresponsiveness. Proc. Nat. Adv. Study Inst., San Moniato*, 29 Aug. to 8 Sept., 1982, pp. 39-42, N. Y., 1983
15. LIVSHITS, M. A., *Biofizika* 17: 694, 1972
16. FRÖHLICH, H., *Ibid.* 22: 743, 1977
17. WU, T. M. and AUSTIN, S., *Phys. Lett.* 65A: 74, 1978
18. YUSHINA, M. Ya., *Ibid.* 91A: 372, 1982
19. FRÖHLICH, H., *Ibid.* 26A: 402, 1968
20. LEBEDEV, I. V., *Technique and U.H.F. Instruments* (in Russian) Vol. II, 375 pp., Vyssh. shk., Moscow, 1972
21. SILIN, R. A. and SAZONOV, V. P., *Retarding Systems* (in Russian) 632 pp., Sov. Radio, Moscow, 1966
22. POHL, H. A., *Coherent Excitations in Biological Systems*, pp. 199-210, Springer, Berlin-Heidelberg, 1983
23. SOTNIKOV, O. S., *Dynamics of the Structure of the Live Neurone* (in Russian) 160 pp., Nauka, Leningrad, 1985
24. GOLANT, M. B. *et al.*, *Effect of Non-Thermal Exposure to Millimetre Radiation on Biological Objects* (in Russian) pp. 115-122, IRE, Akad. Nauk SSSR, Moscow, 1983
25. DEVYATKOV, N. D. *et al.*, *Biofizika* 28: 895, 1983
26. DIDENKO, N. P. *et al.*, *Effect of Non-Thermal Exposure to Millimetre Radiation on Biological Objects* (in Russian) pp. 63-77, IRE, Akad. Nauk SSSR, Moscow, 1983

27. DIDENKO, N. P. *et al.*, Pis'ma v ZhTF 11: 1515, 1985
28. DIDENKO, N. P. *et al.*, Proc. of the Nuclear Physics Research Institute at the Tomsk Polytechnical Institute (in Russian) No. 10, pp. 77-81, Energoizdat, Moscow, 1983
29. DIDENKO, N. P. *et al.*, Summaries of Reports of Sixth All-Union Seminar "Use of Millimetre Low Intensity Radiation in Biology and Medicine" (in Russian) p. 40, IRE, Akad. Nauk SSSR, Moscow, 1986
30. AMELIN, G. P. *et al.*, Tomsk, 1986—Dep. in VINITI, 17 January 1986 as No. 319V-86
31. FRAUENFELDER, H., Helvet. Phys. Acta 57: 165, 1984
32. FRAUENFELDER, H. and GRATTON, E., Protein Dynamics and Hydration, Univ. Illinois, 1985. Preprint III-(ex)-85-1, 26 pp.
33. ANSARI, A. *et al.*, Proc. Nat. Acad. Sci. Wash. 82: 5000, 1985
34. ZHDANOV, V. P., Rate of Chemical Reactions (in Russian) 101 pp., Nauka, Moscow, 1986
35. RAPPOPORT, S. M., Medizinische Biochemie. Veb. Verlag, "Volk und Gesundheit", Berlin, 1964
36. CHOU, K. C., Biophys. Chem. 20: 61, 1984
37. TUSHMALOVA, N. A. and NARAKUYEVA, I. V., Comparative Physiological Studies of Ultrastructural Aspects of Memory (in Russian) 148 pp., Nauka, Moscow, 1986

Biophysics Vol. 34, No. 6, pp. 1098-1104, 1989
Printed in Poland

0006-3509/89 \$10.00 + .00
© 1991 Pergamon Press plc

ACTIVATION ENERGY AND ANALYSIS OF POSSIBLE PATHWAYS OF PHOTOSYNTHETIC EVOLUTION OF OXYGEN*

L. I. KRISHTALIK

Frumkin Institute of Electrochemistry, U.S.S.R. Academy of Sciences, Moscow

(Received 23 July 1987)

From analysis of the main contributions to the activation energy of a series of stages of oxidation of water to O_2 the following conclusions are drawn: the barrier set up by the repulsion of unbound O atoms on their convergence is partially overcome through the energy of binding of the water molecules by manganese ions. Concerted electron and proton transfer with the participation of bases stronger than water greatly improves the energetics of the process; the most probable pathway of the reaction is the rate-determining two-electron oxidation of water to hydrogen peroxide (the possibility of this process taking place in two successive single-electron stages is not clear) with two subsequent fast stages of oxidation of H_2O_2 to HO_2 and then to O_2 .

In references [1, 2] we considered the equilibrium values of the changes in the configurational free energy of the reaction of evolution of O_2 as a whole and its individual stages. We now look at the factors determining the height of the activation barrier. Let us

* Biofizika 34: No. 6, 1015-1020, 1989.

part from the ger

The values figurin
of convergence of
and the reorganiza
tion

where ΔG_2^0 refers
Convergent ene
since the distance

Diagrams of the pote
different values of the
O—O bonds in H_2O_2
repulsion equal to 0.6

less than the sum o
ulate ΔG_{app} on form
is described by the f
[3] (curve 3, Figure

TAB

M. B. GOLANT

terminant role of the protein carcass in the cooperative effects in the membrane. The phenomena due to rearrangement of the membrane carcass and cytoskeleton are analysed in relation to protease-induced adhesion of fibroblasts, the mechanisms of functioning of highly permeable gap contacts and the excitability of the neurone membranes. From the analysis made the concept of the participation of the cytoskeleton both in local and remote regulation of the receptors, enzyme systems and ionic channels is formulated.

The controlling role of the generalized structural transitions is traced not only in the membranes of individual cells but also at the level of intercellular interactions. Thus, the membrane rearrangements induced by the contacts between the surfaces of neighbouring cells, in the view of the author, are an important factor in inhibiting animal cell division and regulating the size of microbial populations.

A special place in the book is occupied by an outline of new ideas on nonequilibrium, metastable states of the membrane structures determined by the interaction of the membrane carcass and the lipid bilayer, the transmembrane potential and the surface membrane charge. Thanks to this metastability sustained through the energy of metabolism, non-decaying spread of the structural transitions over a considerable distance proves possible.

The book by S. V. Konev is literally saturated with similar original concepts, sometimes apparently debatable but invariably stimulating the creative thinking of researchers working in one of the most interesting fields of biophysics, exploring the mechanisms of the functioning of supra-molecular structures of the cell.

Biophysics Vol. 34 No. 2, pp. 370-382, 1989
Printed in Poland

0006-3509/89 \$10.00 + .00
© 1990 Pergamon Press plc

PROBLEM OF THE RESONANCE ACTION OF COHERENT ELECTROMAGNETIC RADIATIONS OF THE MILLIMETRE WAVE RANGE ON LIVING ORGANISMS*

M. B. GOLANT

(Received 10 June 1987)

A review is made of Soviet and foreign experimental studies furthering understanding of the mechanism of the acute resonance action of extremely high frequency† coherent electromagnetic radiations of low power on living organisms and the significance of these radiations for the functioning of the latter.

The effect of electromagnetic radiations (e.m.r.) on living organisms was noted long ago (see, for example, [2]) and occasioned no surprise. Physiotherapy and radiobiology are concerned with study of the character of the thermal and radiation effects of e.m.r. and study of the possibility of their practical usage.

* Biofizika 34: No. 2, 339-348, 1989.

† The range of extremely high frequencies (e.h.f.) from 3×10^{10} to 3×10^{11} Hz corresponds to the millimetre wave range from 1 to 10 mm [1].

Action of e

However, simul
living organisms of
on exposure to which
nature of their actual
radiations was explain
the reproducibility of
and the action was ch
not compared. Howe
did not cease and it we
techniques in work w

At the start of the
N. D. Devyatkov emba
level on living organisms
up the first series of gen
the specific features of
quency ranges [4] sugg
radiations. Later, the sp
tion to the problems of
For any sufficiently
their reaction to agents
functioning of the system
gularities of the behavior
first systematic experime

IDENTIFI
COHERENT E.I

The first series of ex
tions, or artefacts, of col
e.h.f. radiations) on livin
was undertaken on organ
The results have been re
views of the first 70 public
described and the main
ments confirming these p
is desirable without di
ented in the course of th
ified on their basis.

1. The dependence
on the body is of an acu
quency bands (usually
2. The effects obser
to the density of the inci
amounting for different
of magnitude for a singl
3. The memorizatio
exposure of the resulting
is of sufficient length: fr
4. The biological et
of the body. Single e.h.f

However, simultaneously there appeared data on the effective influence on the functioning of living organisms of non-ionizing radiations of low power (so-called non-thermal level of power) on exposure to which heating of the tissues does not exceed 0.1 K. It was difficult to understand the nature of their actual presence from the same standpoint from which the action of more powerful radiations was explained. Many considered that it is a matter of artefacts particularly since at first the reproducibility of the results was extremely poor. The data referred to different biological objects and the action was characterized by different biological parameters and the acting factors were also not compared. However, communications on non-thermal actions of electromagnetic radiations did not cease and it would be impermissible to ignore them if only from the point of view of the safety techniques in work with radiations.

At the start of the 'sixties a number of teams under the joint scientific direction of Academician N. D. Devyatkov embarked on a systematic study of the action of coherent radiations of non-thermal level on living organisms. The work was conducted in the e.h.f. range [3] since in the course of setting up the first series of generators covering this range Academician Devyatkov and the author identified the specific features of e.h.f. radiations both as compared with lower frequency and far higher frequency ranges [4] suggesting the possibility of an enhanced reaction of living organisms to these radiations. Later, the special possibilities of using the radiations of this range were validated in relation to the problems of medicine and biology [5].

For any sufficiently complex system, primarily for living organisms, study of the features of their reaction to agents must begin by answering the question of the role of these agents in the functioning of the system or organism. The answer to this question may give knowledge on the regularities of the behaviour of the agent. Therefore, study of these patterns was the main aim of the first systematic experimental investigations.

IDENTIFICATION OF THE BASIC PATTERNS OF THE ACTION OF COHERENT E.H.F. RADIATIONS OF NON-THERMAL LEVEL OF POWER ON LIVING ORGANISMS

The first series of experiments sought to clarify the question on the reality of the effective actions, or artefacts, of coherent e.h.f. radiations of non-thermal intensity (hereafter for brevity called e.h.f. radiations) on living organisms and if such actions exist to identify their basic patterns. It was undertaken on organisms of differing complexity of organization (from bacteria to mammals). The results have been repeatedly and quite amply discussed in the literature. In particular, the reviews of the first 70 publications are given in [6, 7]; in references [8, 9] the technique of the experiment is described and the main patterns, later also treated in reference [10], presented. Subsequent experiments confirming these patterns were also undertaken abroad (see, for example, [11, 12]). Therefore, it is desirable without digressing on a repetition of these experiments (the main results will be presented in the course of the exposition) to begin straight away with formulations of the patterns identified on their basis.

1. The dependence of the biological effect on the frequency of coherent e.h.f. radiation acting on the body is of an acute resonance character, i.e. the response to the agent occurs in narrow frequency bands (usually $\sim 10^{-3}$ - 10^{-4} of average frequency).

2. The effects observed in a certain fixed time of the action of e.h.f. radiation are not critical to the density of the incident flow of energy. Starting from a certain minimum (threshold) density amounting for different organisms to 0.01-100 mW/cm² the subsequent rise in flow by 2-3 orders of magnitude for a single action does not, as a rule, influence the biological effect.

3. The memorization of the action of the e.h.f. - persistence for a long time after arrest of the exposure of the resulting changes in the functioning of the organism - ensues only when irradiation is of sufficient length: from a few tens of minutes to a few hours.

4. The biological effects of the action of e.h.f. radiations closely depend on the initial state of the body. Single e.h.f. irradiation does not significantly influence the current functioning of the

healthy organism. If any of the functions of the organism is disturbed, exposure to coherent e.h.f. radiations may in many cases restore it.

It is important to note that heat exposure cannot give effects satisfying these patterns. This, of course, does not exclude the existence of purely thermal effects weakly depending on frequency and corresponding to low levels of the acting power flux [13, 14].

To form ideas from the experiments on the nature of the action of e.h.f. radiations on living organisms a major role is played by the common nature of the patterns presented for organisms of different complexity of organization. This allows one to use the data of many investigations and not to confine the field of the investigations to the characteristics of any one object.

Analysis of the patterns listed outlined in the greatest detail in [14, 15] suggested two main conclusions.

a) The effect of coherent e.h.f. radiations on living organisms adds up to the control of the restorative processes occurring in them and processes of adaptation to the changing conditions of functioning; and

b) the effectiveness of the acute resonance action on the organism of radiations originating from sources of coherent oscillations external in relation to it is connected with the fact that these radiations may excite in the organism coherent e.h.f. oscillations simultaneous signals generated in certain conditions by the organisms themselves. A similar conclusion is also contained in reference [16].

However, the passage from the patterns outlined to these conclusions at first ran through complex logical reasoning. The question of more direct experimental evidence retained its acuity, namely the present review is devoted to a description of it. The material will be outlined in the order and way in which it may serve for answering the specifically posed questions corresponding to the problem under study. The choice of the experiments described in each case is determined by the completeness of the answer to the question posed ensured by them.

In order to fit into the volume of the paper the information necessary for illuminating the most important aspects of the problem the material will be given without going into details which are contained in the quoted sources. In particular, the communications [11, 17, 18] are specially devoted to the question of possible experimental errors. Here, we would merely note that in the experiments described below in nearly all cases the range of changes occurring on exposure to e.h.f. radiations was far smaller than the mean value of these changes.

LINK BETWEEN THE ACUTE RESONANCE CHARACTER OF THE RESPONSES OF ORGANISMS TO THE ACTION OF E.H.F. RADIATIONS AND THE INFORMATION FUNCTION* OF THE LATTER

For the comprehensive control of the functioning of an organism many control signals differing from each other are necessary. The acuity of the resonance responses of the body to irradiation (narrowness of the frequency band, see, for example, Fig. 1) characterizing the first of the above formulated patterns contributes to the formation on the basis of them of a large number of different spectra. But to answer the question of how far the acute resonance nature of the responses of the organisms to the action of e.h.f. radiations may indicate the information function of the latter, it was first necessary to satisfy ourselves that a large number of such resonance response actually exists. The action spectra [12, 19] given in Fig. 2—dependence of a certain biological parameter on frequency—confirmed that the position is actually so. † Similar dependences had already been registered in reference [20], only the number of identified resonances was smaller. With such a density of accommodation of the resonance bands in the frequency range their combinations in the spectra may ensure a huge variety of signals. But this will correspond to the diversity of control only with the

* Below by information function we mean the role of e.h.f. radiations as control signals.

† We would note that in reference [19] for some resonance curves from among those shown in Fig. 2b, we present a large number of experimental points.

Fig. 1. Induction co

condition that to each other. The action spe in fulfilled. They refle

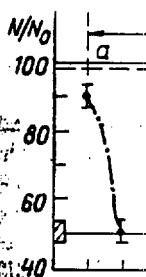
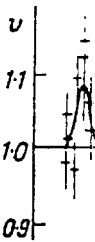

2. Dependence of the character of the char on frequency [12] (a) and dependence of the character of the char on frequency with X-ray

acter of the char on frequency to provide an answer to the question, if feasible

coherent a
 attens. Th
 on frequen
 ons on living
 or organisms
 tigtions and
 ed two main
 ontrol of the
 onditions of
 s originating
 ct that these
 generated in
 ed in refer
 ran through
 d its acuity
 in the order
 ading to the
 ined by the
 ing the most
 s which are
 pecially de
 t in the ex
 ure to e.h.f.

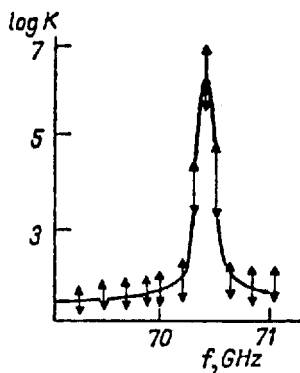

FIG. 1. Induction coefficient of lambda prophage as a function of the frequency of the acting radiation [11].

condition that to each of these bands correspond states of the organism somehow differing from each other. The action spectra presented do not answer the question of whether or not the last condition is fulfilled. They reflect the dependence on frequency of only one single biological parameter and the

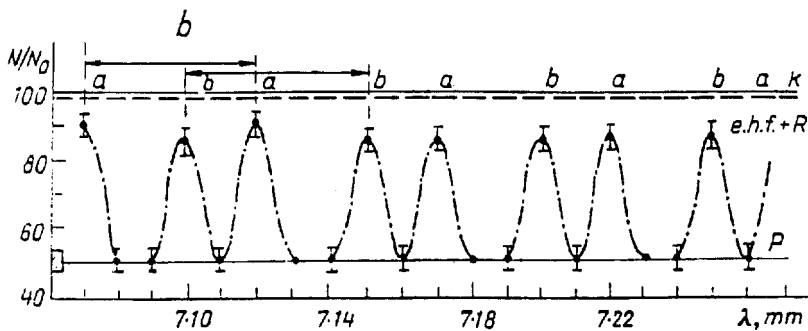
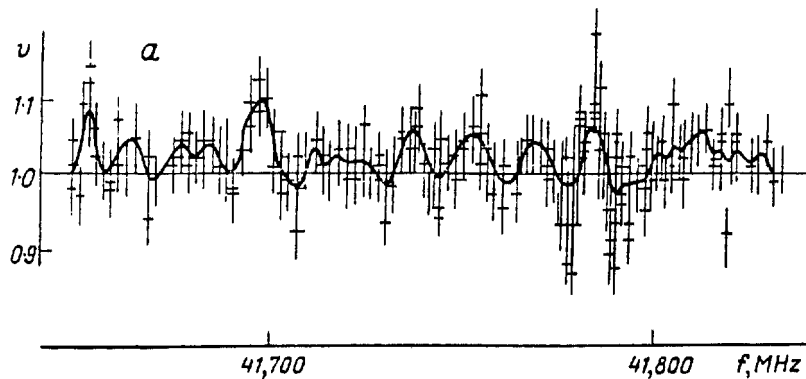

FIG. 2. Dependences of the normalized growth rate of a yeast culture on the frequency of the acting radiation [12] (a) and change in the number of karyocytes (N/N_0) after exposure to e.h.f. combined with X-radiation with the wavelength of e.h.f. radiations in free space [19] (b).

character of the change in the other parameters is not defined. Moreover, biological methods cannot provide an answer to this question since complete examination of the biological object is extremely laborious, if feasible at all [21].

IONS
 signals dif
 irradiation
 f the above
 of different
 uses of the
 he latter, it
 ually exists.
 eter on fre-
 a registered
 density of
 pectra may
 ly with the

signals.
 ose shown

A certain but insufficiently complete answer to this question is given by experiments on the detection of the frequencies of exposure optimal in terms of the maximum intensification of different processes in the organism [22]. The results of one such investigation are given in Fig. 3. Since the frequencies optimal in terms of reaching the maximum changes of arbitrarily chosen parameters are usually scattered far apart the corresponding experiments cannot give an answer to the question of the differences in the effects on the organism in near resonance bands.

ONE OF THE POSSIBLE WAYS OF IDENTIFYING THE LINK BETWEEN THE GENERAL STATE OF THE BODY AND THE FREQUENCY OF THE E.H.F. RADIATION ACTING ON IT

Since the detection of all the changes occurring in the body separately is impossible a different approach to answering the question was substantiated and experimentally worked out [23]. Some integral characteristics exist influenced by all or nearly all the changes occurring in the cells. Such an integral characteristic is, in particular, the duration of the cycle of development of the cell between successive divisions (hereafter, for brevity duration of the cycle). In so-called synchronous cell cultures it is possible to select cells with almost identical parameters and ensure the simultaneity of the first acts of their division. But even with the strictest selection the synchrony of cell division already after a few cycles is disturbed with transition to exponential growth of the cell count (Fig. 4a).

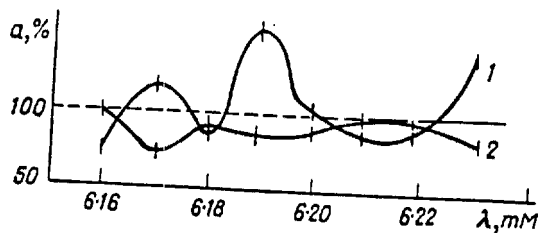

FIG. 3

FIG. 3. Enzymatic activity of *Asp. awamory* 466 (in relation to control) as a function of the wavelength of the acting radiation in free space for two different substrates [22]: 1—alpha amylase; 2—glucoamylase.

FIG. 4. Curves of the synchronous division of yeast cells: a—not exposed to e.h.f. radiation; b—exposed [23]; n/n_0 is the ratio of the cell counts in the suspension to the initial value; τ is time in cycles of development between successive divisions, duration of cycle 1 hr.

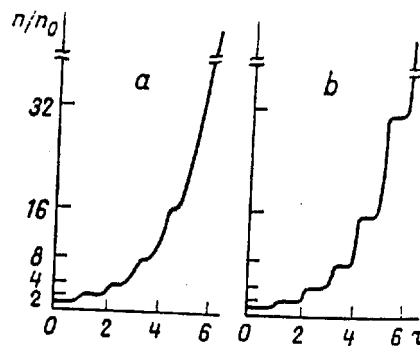

FIG. 4

It has been assumed that a difference in the duration of the cycle is connected with the difference in the frequencies of the e.h.f. oscillations generated by the cells. In fact, after synchronization of these oscillations in the course of relatively brief (in different conditions from several tens of minutes to two hours) exposure to a coherent signal of non-thermal intensity from an external source of e.h.f. radiations the difference in the duration of the cycle for different cells was virtually removed and reflected in the constancy of the duration of the steps (Fig. 4b). A similar effect can also be obtained through mutual synchronization of the oscillations in the cells without resorting to an external emitter. For this it suffices to amplify the emission of the cells. As shown in [24, 25] amplification of emission can be achieved, in particular, by introducing into the cell suspension long-fibrous molecules acting as antenna (this will be examined below in more detail).

Action c

At the same generate, in prin scribing the inte fectively interact animals.

In the course tions by an exte

FIG. 5. Duration

proportional to ti parison of this re nces of one spec parameters influ characteristics. Conse qu in some way fro . At the same indicates that eve tions generated by the organism as a

The large nu h.f. radiation le uring resonance tion in which th wavelengths in the per unit number of of the type of osci and described in [

The waveleng the cell (micro rchted system is e the waves in a mul Thus, the exp the cells to ele dging from the c the cells. For th acoustic-electric et by the losses e order of centimetre

At the same time, different cells, for example single-type cells of different animals apparently generate, in principle, different frequencies not amenable to mutual synchronization. In [25] describing the interaction of erythrocytes it was established that only those of the same animals effectively interact (attract each other); they find each other even in a suspension of cells of different animals.

In the course of the above-described experiments on synchronization of the cell-generated oscillations by an external e.h.f. signal the duration of the cycle was found to depend on frequency: it was

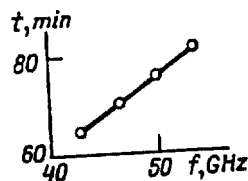

FIG. 5. Duration of cycle of development of yeast cells between successive divisions as a function of the frequency of the e.h.f. radiation acting on them.

proportional to the frequency of the signal synchronizing the oscillations in the cells (Fig. 5). Comparison of this result with the action spectra (Fig. 2) indicates that together with resonance dependences of one specific parameter on frequency there is gradual change with frequency in a set of other parameters influencing the duration of the cycle. This is reflected in change in the integral characteristics. Consequently, to each of the resonance bands correspond changes in the body differing in some way from each other.

At the same time the smoothness of change with the frequency of the integral characteristic indicates that even the individual parameters of the cell with change in the frequency of the oscillations generated by it change gradually so that it may be expected that at close resonance frequencies the organism as a whole changes relatively little.

WHAT STRUCTURES DETERMINE THE RESONANCE NATURE OF THE RESPONSE OF THE ORGANISM TO E.H.F. EXPOSURE?

The large number and regularity of lines in the action spectra shown in Fig. 2 indicate that e.h.f. radiation leads to excitation of multimodal resonance systems. Shift in $\Delta\lambda$ between the neighbouring resonances in wavelength in the free space and the value λ of the mean wavelength in the region in which the spectrum is recorded (see Fig. 2) make it possible to determine the number of wavelengths in the excited resonance system $N = \lambda / |\Delta\lambda|$. (With this condition $\Delta\lambda$ corresponds to change per unit number of wavelength accommodated in a closed resonance system, i.e. transition to resonance of the type of oscillations closest to the initial.) Thus, for example, in the experiments run with cells and described in [20] $N \approx 200$. In the experiments described in reference [12] $N \approx 1500$ (see Fig. 2).

The wavelength in the system in order of magnitude must be equal to the ratio of the perimeter of the cell (microns) to tens of microns) to the magnitude N indicated, i.e. the wavelength in the excited system is $\sim 10^6$ times shorter than that in the free space [24] and this, in turn, indicates that the waves in a multimodal resonance system spread at the velocity of sound (in order of magnitude).

Thus, the experimentally established nature of the action spectra indicates that on exposure of the cells to electromagnetic radiations acoustic-electric oscillations are excited in them [24]. Judging from the character of the action spectra in mammals (Fig. 2b) they are also due to resonances in the cells. For the oscillations to be excited by electromagnetic waves the losses on the propagation of acoustic-electric oscillations in the resonance system must be relatively low. This requirement is met by the losses on propagation of the e.h.f. in a lipid medium (10-fold decay at distances of the order of centimetres [26]). Such distances are very large as compared with any intracellular dimen-

sions. This led to the conclusion that the role of the multimodal resonance systems may be played by lipid membranes [27, 28]. But the membranes are surrounded by cytoplasm—a medium representing aqueous salt solutions (hereafter for brevity called an aqueous medium) characterized by heavy ohmic losses. Does not this make resonance excitation of the membranes impossible? The investigations described in reference [29] showed that the hydrophobic part of the membranes with low losses is separated from the hydrophilic (directly contiguous to the aqueous medium) by layers of thickness $\sim 10 \text{ \AA}$. At the same time the above-indicated value of the delay of wave propagation ($\sim 10^6$) corresponds to fall by an order in the density of the power flux of e.h.f. also over a distance $\sim 10 \text{ \AA}$ [30]. Therefore, an e.h.f. field of sharply reduced amplitude reaches the aqueous medium and the ohmic losses in it do not impede resonance excitation of the oscillations in the membranes.

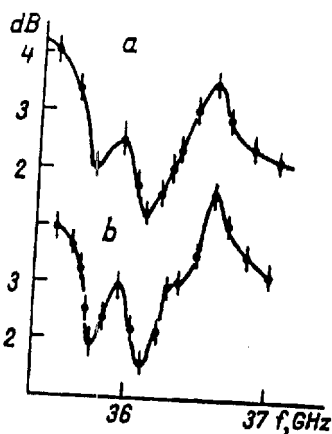

FIG. 6

FIG. 6. Absorption spectra of: *a*—erythrocytes; *b*—erythrocyte ghosts [31].

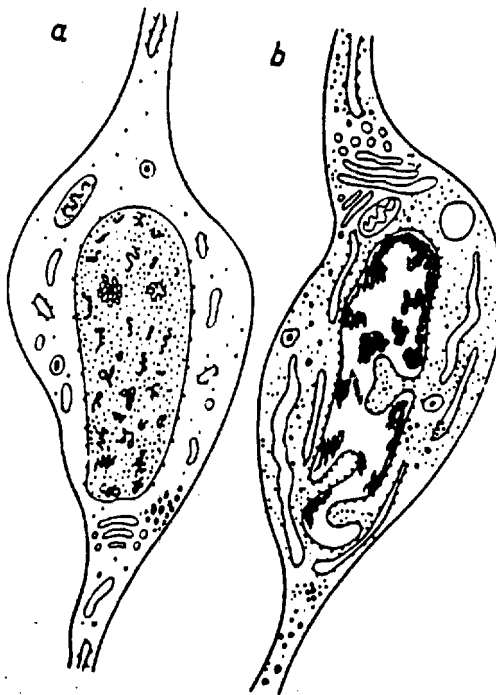

FIG. 7

FIG. 7. Formation during memorization of protein structures on the surface of the nuclear membranes of ganglionic elements of hydra [33]: *a*—normal state; *b*—adaption.

In principle, *a priori*, the resonances observed in study of the action spectra cannot be equated with those on excitation by e.h.f. fields of passive electrodynamic structures. The difference is that in experimental study of the action spectra the biological effect is the discrete output parameter. The biological effect is linked by a complex non-linear dependence to the fields acting on the membrane and in a complex metabolic system the initial action of the field may be enhanced which, in turn, may lead to fixation of even weak differences in the acting field.*

The experiments described in [31] with recording of the absorption spectra of the erythrocytes and their ghosts (i.e. erythrocyte membranes freed of cytoplasm) showed that the spectra in both

* In certain conditions the ohmic losses for the waves spreading in the membranes may rise considerably leading to difficulties in the experimental detection of resonance frequencies.

Acti

cases are ver-
tions precisel
of e.h.f. on

WHAT

In line v
fluence exerte
lished under
multimodal a
tures are used
In the case of
the organism
of memorizat
exposure to a
Deeper st
In the course
exposure for
the pulse radi
was close to th
Thus, the mea
nuous exposu
be drawn from
Firstly, th
by e.h.f. radiat
causes betwee
the e.h.f. oscill
with shortenin
of the action a
structures fix
Nor did th
logical investig
widely conduct
Established tha
membranes of
forgetting a

Firstly, th
by e.h.f. radiat
causes betwee
the e.h.f. oscill
with shortenin
of the action a
structures fix

Nor did th
logical investig
widely conduct
Established tha

membranes of
forgetting a

INFLUENCE ON OF FOR

Unlike ene
ined by the en
primarily det
sponds to the
ower does not
but the volume
ous section
the membran
erated by the
the given stru
elements

cases are very close (Fig. 6). This is direct confirmation of the fact that the e.h.f. may excite oscillations precisely in the membranes and allows one to tie the observed biological effects of the action of e.h.f. on the cells to the resonance frequencies of the excited oscillations.

WHAT ENABLES LIVING ORGANISMS TO MEMORIZE E.H.F. EXPOSURES AND ACCORDINGLY CHANGE THE CHARACTER OF THEIR FUNCTIONING?

In line with the third of the above listed patterns living organisms memorize the external influence exerted on them and after its arrest continue to generate for a long time the frequencies established under its influence determining the changes in the character of functioning. In technical multimodal auto-oscillatory systems to fix excitation for certain types of oscillations special structures are used determining the most favourable conditions of excitation for these types of oscillations. In the case of living organisms the structures fixing the type of oscillations could be created only by the organism itself in the period of the action on it of the e.h.f. radiations. The duration of the process of memorization already led to the conclusion that such structures are formed in the organism on exposure to an e.h.f. (see above); it might be determined by the time of construction of the structure.

Deeper study of the question may be furthered by the results of experiments described in [32]. In the course of these experiments conducted on mice it was shown that the biological effect of e.h.f. exposure for 1 hr does not change if continuous is replaced by pulsed irradiation with a power of the pulse radiation equal to the power of the continuous. The power of the continuous exposure was close to the threshold value (see pattern 2) and the porosity on pulse exposure was equal to six. Thus, the mean power on pulse exposure was several times lower than the threshold value for continuous exposure. The duration of the intervals was 2×10^{-3} sec. The following conclusions could be drawn from the results.

Firstly, the character of the biological effect in the pulsed and continuous regimes of exposure to e.h.f. radiations is the same if the frequencies of the acting oscillations match. Secondly, in the pauses between pulses when the external irradiation of the animal is absent, in the organism itself the e.h.f. oscillations stay at a level close to that established in the period of the pulse and, thirdly, with shortening of the total duration of exposure the biological effects determined by memorization of the action are not observed. Consequently, one or a small number of pulses is insufficient to give structures fixing the new (resulting from irradiation) state of the body.

Nor did these experiments allow us to judge the character of the structures formed. Morphological investigations were necessary to determine it. Such morphological investigations have been widely conducted in connexion with study of the ultrastructure of aspects of memory [33]. It was established that the memorization process in the cells leads, in particular, to the formation on their membranes of structures adhering to the latter (we shall call them informational) which in the process of forgetting again pass to the cytoplasm (Fig. 7).

INFLUENCE OF THE POWER OF EXTERNAL E.H.F. SIGNALS ACTING ON ORGANISMS ON THE BIOLOGICAL EFFECT OF THE ACTION AND ON THE DYNAMICS OF FORMATION OF STRUCTURES DETERMINING THE MEMORIZATION OF THE RESULTS OF EXPOSURE TO AN E.H.F.

Unlike energy factors acting on living organisms (factors for which the biological effect is determined by the energy coming from without) the biological effect of the informational e.h.f. influences is primarily determined by the information content of the signal (its frequency spectrum if it corresponds to the natural frequencies of the biological system) and in a wide interval of changes of power does not depend on the size of the latter (see pattern 2 and Fig. 8 reflecting it). This indicates that the volume of the near-membrane aggregates in the informational structures described in the previous section starting from a certain value weakly influences the character of the e.h.f. field formed by the membrane. In terms of e.h.f. electrical engineering this is natural: the frequency of the signals generated by the cell and fixed by the informational structure primarily depends on the character of the given structure. In other words, the frequency to a far higher degree depends on the location of the elements forming the structure than on their size.

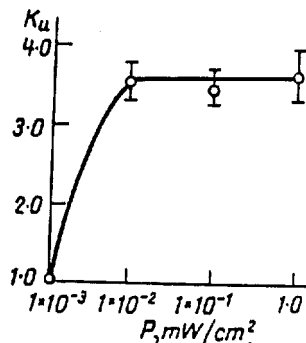

FIG. 8

FIG. 8. Coefficient of induction of synthesis of colitsin as a function of the flow density of e.h.f. radiation [7].

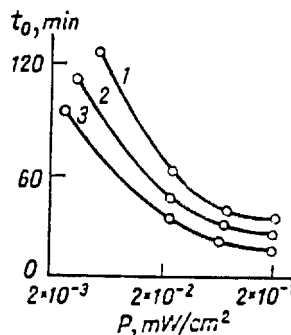

FIG. 9

FIG. 9. Duration of exposure (t_0 —time of irradiation) as a function of the flow density of e.h.f. radiation for an unchanged biological effect: 1—minimum time taken to synchronize oscillations of all cells; 2—time required to synchronize oscillations of 15 per cent of the cells; 3—maximum exposure time for which synchronization of the oscillations of the cells still does not appear.

However, the dynamics of the process of formation of informational structures cannot be influenced by the power of the signal causing them to form. To identify the nature of this influence a series of experiments was run. They determined, in particular, the dependence of the degree of synchronization of the oscillations in yeast cells on the duration and power of the signal acting on the cell suspension. The results of such an experiment are given in Fig. 9. The character of the dependence of the degree of synchronization on time is quite trivial. The greater the initial shift of frequencies of the oscillations generated by the cells from the frequency of the synchronizing signal the longer must be the process of synchronization determined by the rearrangement of the structure adhering to the membranes. Comparison of the dependences of the degree of formation of the informational structures on the exposure time and the power of the acting signal allows one to judge a great deal.

As may be seen from Fig. 9, the power of the e.h.f. signal is connected with the time of exposure required to achieve a certain biological effect, a dependence close to exponential. With what is this connected? The biological effect is determined by the formation of informational structures. It may be assumed that acceleration of this process is connected with enlistment for their formation of protein molecules from layers of the cytoplasm more distant from the membrane but the e.h.f. field on moving away from the membrane drops exponentially (see above). Therefore, for the e.h.f. field forming the structures to reach the required value at a larger distance from the membrane the exponential drop of the field must be compensated by an exponential rise in the external e.h.f. signal.

It should be noted that thanks to fall in the amplitude of the e.h.f. field in a direction perpendicular to the membrane surface the molecules shift under the influence of the field not so much along this surface as are attracted to it [34]. Therefore, the process of the action of the e.h.f. field described on the molecules in the volume of the cytoplasm explains not only the process of the formation of informational structures on the membranes (see, for example, Fig. 7) but also the process of drawing the protein molecules described in reference [35] to the surface of the membrane (Fig. 10) in conditions unfavourable for the functioning of the cell, i.e. in periods when in it restorative and adaptative processes develop. Apparently this process of drawing the protein molecules to the membrane surface organized by the e.h.f. field indicates that the role of the e.h.f. signals is not confined to determination of the "direction" of the restorative activity of the cell. They take part in the process of mobilization of its resources which is greater and more rapid the more intense the controlling signal.

tion of the phenomenon, the authors of reference [23] ran the following experiment similar to those described above with synchronization of the cell-generated oscillations by the external monochromatic e.h.f. signal. The only difference was that irradiation was with a signal modulated in frequency. The results are given in Fig. 12 showing that the greater the amplitude of frequency modulation (inevitability causing some initial desynchronization of the oscillations in the cells) the greater must be the power of the signal to achieve in a fixed time period a certain degree of synchronicity of cell division. Rise in the power required for synchronization with increase in the amplitude of frequency modulation is of an exponential character.

In line with the analysis made in the preceding section the character of the dependence observed indices that in conditions of low coherence of the oscillations in the cells control of their functioning calls for high mobilization of the cell resources. This, in turn, may explain why the not-young organism with its weakened links (including electromagnetic) apparently already unable to ensure high coherence of the generated signals is more subject to disturbances and diseases. Consequently, it may explain why in the case of upsets of the functioning of the organism associated with disturbance of the intercellular or intracellular links (which would not cause this upset) exposure to external coherent e.h.f. signals at certain, i.e. determined by the character of the disturbance, frequencies has a beneficial effect on the restoration of normal functioning.

We would note that the last experiment is very illustrative in terms of showing the non-thermal nature of the action of the e.h.f. effect: frequency modulation in a narrow range has practically no effect on the energy absorbed by the cells. At the same time as may be seen from Fig. 12, maintenance of the biological effect requires an exponential increase in the energy expenditure.

INTERCELLULAR E.H.F. LINK AND E.H.F. LINK IN THE VOLUME OF THE INTEGRAL MULTICELLULAR ORGANISM

The preceding sections were mainly concerned with experiments involving intracellular processes. However, the experimentally established patterns presented equally apply to multicellular organisms and in the last case the local e.h.f. exposures may influence change in the functioning of the regions of the body quite remote from the irradiating surface.

This calls for experiments answering the following questions: 1) how can the e.h.f. signals generated by the cells be emitted beyond the cell (we would recall that as shown above the e.h.f. field in the normal state of the cell is pressed to the membrane surface over a distance ~ 1 nm); and 2) over which channels can the e.h.f. signals in the organisms spread over large distances?

The first of these questions may be answered by the investigations [24] showing that emissions of the e.h.f. signals from the cell may be enhanced if on the membrane surface projections form with a height of several tens of Ångströms especially if several such projections acting as antennae shift relative to each other by distances close to the wavelength in the membrane (~ 100 Å) for the middle part of the e.h.f. range. In fact, the photographs of the membranes recorded with an electron microscope corresponding to the periods when the normal functioning of the cells was disturbed in one way or another revealed such projections—septa (near-membrane aggregates) with the dimensions indicated above [35] (Fig. 13). Such antennae may be used to transform part of the energy of the retarded to the energy of the non-retarded wave.

If the antennae are situated at points of the resonance system at which the oscillations have an identical phase, i.e. at points separated by distances equal to a whole number of wavelengths, and the length of the antennae is sufficient to take the oscillations from these points to the region where the amplitude of the retarded wave is heavily reduced then in this region the set of antennae will excite the non-retarded wave since at each given moment the field at the ends of these antennae is identical. Naturally, the non-retarded wave may be excited (though less effectively) by a single antenna.

The main means of propagation in the body over distances of information associated with the excited e.h.f. oscillations appears to be the nervous system. The experiments of Sevast'yanova showed that anaesthesia like the sectioning of nerve fibres lessens the influence of e.h.f. impacts on the func-

Action
tioning of the
nerve fibres th
in reference [2
in the charact
between the n
functioning of

FIG. 12. Depen
cies of the osci

FIG. 13. Form

by the enhance
points of acup
Also possi
blood cells) by
to hand the res

1. Radiocomm
Standards
2. PRESMAN
1968
3. DEVYATK
Objects (in
4. DEVYATK
5. *Idem.*, Pis'n
6. DEVYATK
7. SMOLYAN
8. BAZANOV
9. DEVYATK
10. GOLANT, I
11. WEBB, S. J
12. GRUNDLE
13. DARDELH

tioning of the body. It was assumed that the e.h.f. signals spread via the myelin-lipid sheaths of the nerve fibres the e.h.f. losses in which are minimal (see above). This conclusion was first formulated in reference [25]. Such an assumption is also supported by the changes described in reference [35] in the character of these sheaths in the regions of the nodes of Ranvier helping to establish a link between the neighbouring portions of the myelin sheaths in periods unfavourable for the normal functioning of the body. The probability of an e.h.f. link through the nervous system is also indicated

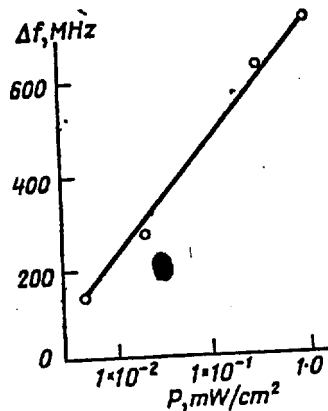

FIG. 12

FIG. 12. Dependence of the maximum amplitude of frequency modulation Δf for which the frequencies of the oscillations in the cells can still be synchronized by external radiation for a power flux density P .

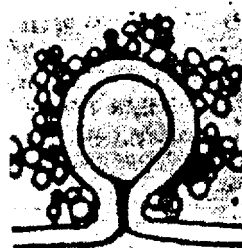

FIG. 13

FIG. 13. Formation of reactive structures of the membrane associated with its activation: endocytotic vesicle covered with protein aggregates [35].

by the enhancement described by the authors of [37] of the effect of e.h.f. signals on the body if the points of acupuncture are directly exposed to e.h.f. radiation.

Also possible is humoral transmission of the e.h.f. signals with the moving cells (primarily the blood cells) by generating oscillations of corresponding frequency. But the author does not have to hand the results of direct experiments confirming this assumption.

REFERENCES

1. Radiocommunications—Terms and Definitions (in Russian) GOST 24375-80 U.S.S.R. State Standards Commission, 1980
2. PRESMAN, A. S., Electromagnetic Fields and Animate Nature (in Russian) Nauka, Moscow, 1968
3. DEVYATKOV, N. D., Effects of Non-Thermal Exposure to Millimetre Radiation on Biological Objects (in Russian) pp. 3-6, IRE, Akad. Nauk SSSR, Moscow, 1983
4. DEVYATKOV, N. D. and GOLANT, M. B., RE, No. 11, 1973, 1967
5. *Idem.*, Pis'ma v ZhTF 12: 288, 1986
6. DEVYATKOV, N. D. *et al.*, Radiobiologiya 21: 163, 1981
7. SMOLYANSKAYA, A. Z. *et al.*, Usp. sovr. biol. 87: 381, 1979
8. BAZANOVA, E. B. *et al.*, Usp. fiz. nauk 110: 455, 1973
9. DEVYATKOV, N. D., *Ibid.* 110: 453, 1973
10. GOLANT, M. B., Biofizika 31: 139, 1986
11. WEBB, S. J., Phys. Lett. A73: 145, 1979
12. GRUNDLER, W. and KEILMANN, F., Phys. Rev. Lett. 51: 1214, 1983
13. DARDELHON, M. *et al.*, J. Microwave Power, No. 14 (4), 307, 1979

14. DEVYATKOV, N. D. *et al.*, Biological Effects of Electromagnetic Fields, Problems of their Use and Standardization (in Russian) pp. 75-94, Pushchino, 1986
15. DEVYATKOV, N. D. and GOLANT, M. G., *Pis'ma v ZhTF* 8: 38, 1982
16. FRÖHLICH, H., Molecular Models, Photoresponsiveness, pp. 39-42, NATO Adv. Study Inst., San Moniato, 29 Aug.-8 Sept. 1982-1983
17. KEILMANN, F., *Collective Phenomena*, Vol. 3, p. 169, 1981
18. BRYUKHOVA, A. K. *et al.*, *Elektron. tekhnika. Elektronika SVCh*, No. 8 (380), 52, 1985
19. SEVAST'YANOVA, L. A. *et al.*, Effects of Non-Thermal Exposure to Millimetre Radiation on Biological Objects (in Russian) pp. 34-47, IRE, Akad. Nauk SSSR, Moscow, 1983
20. VILENSKAYA, R. L. *et al.*, *Nauch. dokl. vyssh. shkoly. Biol. nauki*, No. 7, 59, 1979
21. ALEKSANDROV, V. Ya., *Cell Reactivity and Proteins* (in Russian) 317 pp., Nauka, Leningrad, 1985
22. GOLANT, M. B. *et al.*, Effects of Non-thermal Exposure to Millimetre Radiation on Biological Objects (in Russian) pp. 115-122, IRE, Akad. Nauk SSSR, Moscow, 1983
23. BOZHANOVA, T. P. *et al.*, *Elektron. prom-st'*, No. 1 (159), 35, 1987
24. GOLANT, M. B. and REBROVA, T. B., *Radioelektronika* 29, 10, 1986
25. ROWLANDS, S., *Coherent Excitations in Biological Systems*, pp. 145-161, Springer Verlag, Berlin-Heidelberg, 1983
26. GUERQUIN-KERN, J. L., Thèse présentée à L'Université Louis Pasteur de Strasbourg pour obtenir le titre de Docteur de Spécialité en Electronique et Instrumentation, 1980
27. FRÖLICH, H., *Adv. Electronics Electron. Phys.* 53: 85-152, 1980
28. GOLANT, M. B. and SHASHLOV, V. A., *Use of Low Intensity Millimetre Radiation in Biology and Medicine* (in Russian) pp. 127-132, IRE, Akad. Nauk SSSR, Moscow, 1985
29. IVKOV, B. G. and BYERESTOVSKII, G. M., *Lipid Bilayer of Biological Membranes* (in Russian) 224 pp., Nauka, Moscow, 1982
30. LEBEDEV, I. V., *U.h.f. Techniques and Instruments* (in Russian) 375 pp., Vyssh. shk., Moscow, 1972
31. BLINOWSKA, K. J. *et al.*, *Phys. Lett. A109*: 124, 1985
32. BALIBALOVA, Ye. N. *et al.*, *Elektron. tekhnika. Elektronika SVCh*, No. 8 (344), 6, 1982
33. TUSHMALOVA, N. A. and MARAKUYEVA, I. V., *Comparative Physiological Investigation of Ultrastructural Aspects of Memory* (in Russian) 148 pp., Nauka, Moscow, 1986
34. POHL, H. A., *Coherent Excitations in Biological Systems*, pp. 199-210, Springer Verlag, Berlin-Heidelberg, 1983
35. SOTNIKOV, O. S., *Dynamics of the Structure of the Living Neurone* (in Russian) 160 pp., Nauka, Leningrad, 1985
36. GOLANT, M. B. *et al.*, *Elektron. tekhnika. Elektronika SVCh*, No. 8, 52, 1987
37. ANDREYEV, Ye. A. *et al.*, *Dokl. Akad. Nauk UkrSSR, Ser. E*, No. 10, 60, 1984

BIO

The fact
utilizes t
English.Candida
higher pThe Fac
omedical
specialis
backgroPriority
molecul
develop
design-c
evaluatiThe sale
educatio
and eco
recruitm
year. An
contract
faculty
tificates
referees

T

* The
rec
unt:

TAB

ELF ELECTROMAGNETIC FIELDS AS A NEW ECOLOGICAL PARAMETER

Temurjants, N.A., Sidyakin, V.G., Makejev, V.B.,
Simferopol State University, USSR.
Vladimirsky, B.M.,
Crimean Astrophysics Observatory, USSR.

Summary

A short review of the investigated problem 'Solar activity and the Biosphere' is presented below. The research was being carried out by the Simferopol State University, the Crimean Medical Institute and the Crimean Astrophysics Observatory in the years 1972-1985. The main conclusion is that the effect of solar activity upon medical and biological processes can be explained if one takes into account a new essential parameter in ecology - an electromagnetic background field at the Earth's surface in the VLF - ELF range.

Introduction

The problem of the effect of solar activity upon the Biosphere is an old controversy and has had a long history. At present the problem in question hardly seems to attract the attention of scientists. The overwhelming majority of researchers considers the effects of solar activity on the biosphere to be a myth or at least a pseudoscientific activity of some small groups of 'adherents'. However, we think that there is no basis for such an opinion. For the last ten years strong empirical evidence of correlations between the indices of solar (geomagnetic) activity and some biological parameters (or medical statistical data) has been obtained. In lots of cases these correlations have a strong statistical significance, they are based on a large body of measurements and have been verified by independent groups in different laboratories. Unfortunately, there is no possibility here to present a full survey of the literature on the problem. Some important results were published in the collections of the articles edited by Gnevyshev, M.N. and Ol', A.I. in 1972 /1/ and 1983 /2/ (one more paper is being prepared: /3/). An extensive discussion of the problem under study is given by the authors of the present paper in their monograph /4/.

The interdependence of solar activity variations and biological processes is a widely-spread phenomenon. It has revealed the major divisions of biological systematics including bacteriology, entomology, ornitology, etc. The same type of regularity is observed in many topics of medicine, such as cardiovascular diseases, ophtalmology, nervous system diseases, psychiatry, pediatrics, etc. All the data are conditioned by uncontrolled environmental factors. The most essential feature of this operating agent can be defined by comparing the results of various observations. The main peculiarities are as follows:

1. The operating physical agent penetrates into a laboratory room but it is modified by an electromagnetic screen.
2. This agent is constantly present, and yet it has diurnal and seasonal variations.
3. Some parameters of the agent (intensity?) change with variation of the geographic latitude from the equator to the pole.
4. The modification of the agent parameters due to solar activity variations is controlled both by solar wind variations and ionospheric disturbances.

Of all the known physical factors among the above mentioned characteristics

the variations of the Earth's electromagnetic field intensity in the very low frequency - extremely low frequency range satisfy very well. They are the VLF emission of the magnetosphere, the atmospheric and geomagnetic micropulsations. Nowadays the electromagnetic nature of the operating factors is established by considering the discovery of the biological system's very high sensitivity to electromagnetic fields in the VLF range. This discovery seems to be the most important event throughout the long history of investigating the problem in question.

We present here a short review including the major results of the investigations done by the researchers of the Simferopol State University, the Crimean Medical Institute and the Crimean Astrophysics Observatory. In this paper we shall confine ourselves to exemplifying the most relevant findings without going into additional details (see also /4/ and the references therein).

Influence of very weak electromagnetic fields

Several types of experiments with small intensity alternating magnetic fields have been carried out. Fig. 1 shows typical results obtained for pigeons. The birds were exposed to a magnetic field of 8 Hz-frequency (intensity - 5000 nT) for 3 hours per day. To test the nervous system performance the capacity of fulfilling classical conditioned reflexes was used. In fig. 1 this is shown by the upper curves as a function of time (1: model; 2: experiment). One can see some reduction of the reflexes following the exposure to the field (up to 70%). It should be noted that during magnetic storms the reduction of the reflex performance was also observed (for details see /5/). An influence of alternating magnetic fields on the nervous system of birds measured in different tests was revealed to be dependent upon the electromagnetic field parameters. To study these dependences large numbers of experiments were carried out.

Spectrum measurement of alternating magnetic field
Biological activity

Special series of experiments were done to study the frequency-dependent field activity. Up to 15 different biological indices for rats were measured for each value of frequency. Forty frequencies ranging from 0.01 Hz to 100 Hz for the three intensity levels of 5000 nT, 500 nT and 5 nT were analysed. The experiments were carried out in a special screened chamber. An exposure of 3 hour duration was used in each experiment. The typical situation is given in fig.2. Here the ordinate points to the activity of one of the enzymes in the rat's blood. The abscissa indicates frequency (Hz). Vertical lines at the bottom are measures of the statistical significance of the difference between the model and the experiment. It is evident that the biological effect of the field has a strong dependence upon the frequency: at some frequency values the enzymatic activity is enlarged, at the other it is decreased. Several hundreds of experiments were performed to verify the reproductivity of measurements. As a result, 'active' frequencies were revealed. Within the above-mentioned range these frequencies are as follows: 0.02 Hz, 0.5-0.6 Hz, 5-6 Hz, 8-11 Hz. One of these 'active' frequencies is close to the standard frequency of Pc 3 geomagnetic micropulsations (0.02 Hz). An other such frequency coincides with the well-known fundamental frequency of the ionospheric waveguide (8 Hz). The activity spectrum has been found out to be partly dependant upon the field intensity.

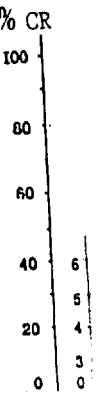

Fig. 1
unde



ry
re
ac-
es-
he
fe-
c
in-
or-
d.
o-
ng
lag-
he
de-
r-
lent
r-
Hz
are
r.
of
y
ni-
vi-
pon
rged,
for-
uen-
e
ne-
the
The
field

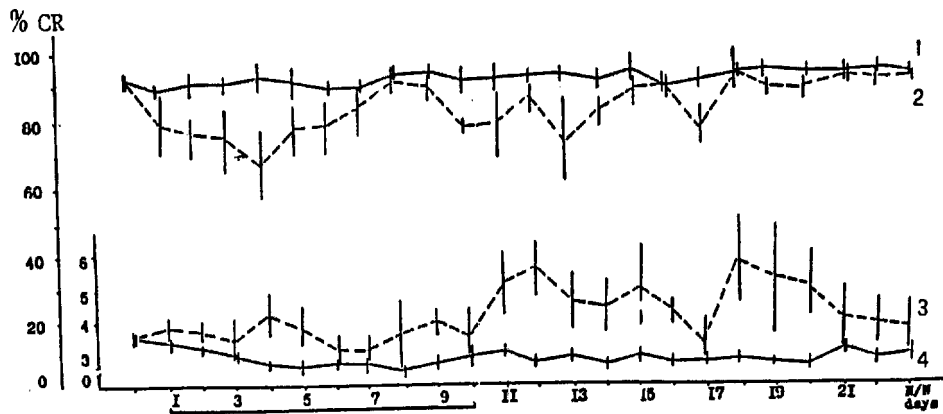

Fig. 1. Condition reflex (2) and motion reaction time (3) for pigeons under the influence of magnetic fields and under normal conditions (1,4)

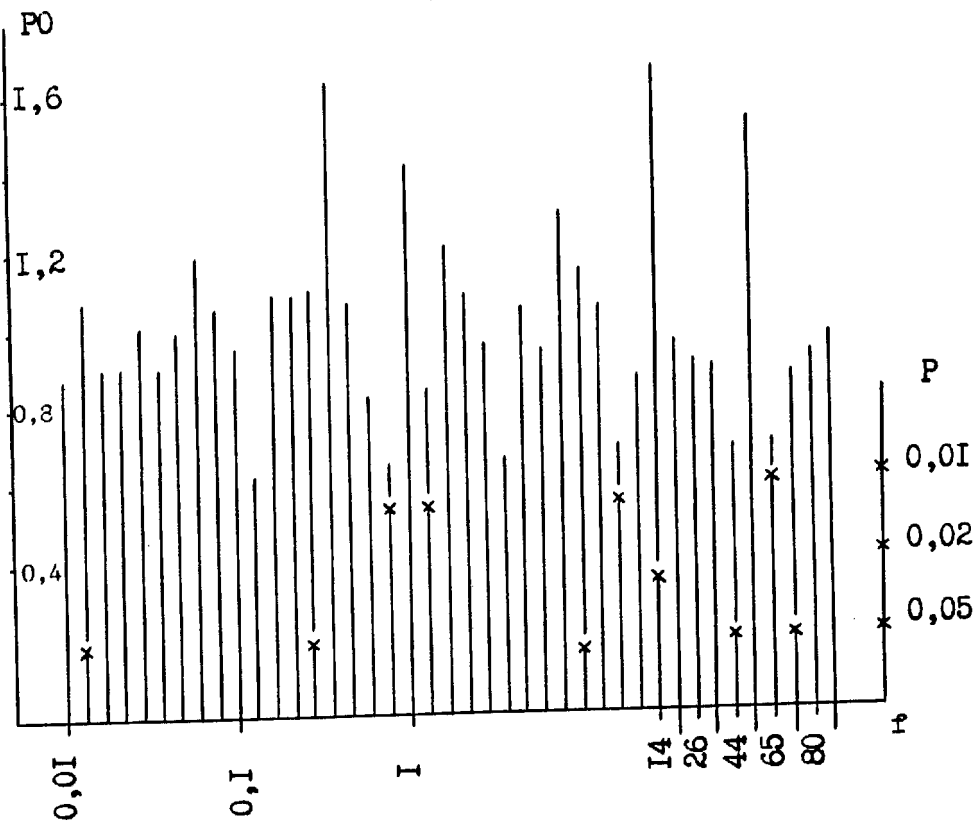

Fig. 2. Frequency-dependent magnetic field activity (peroxidase - PO in neutrophils).

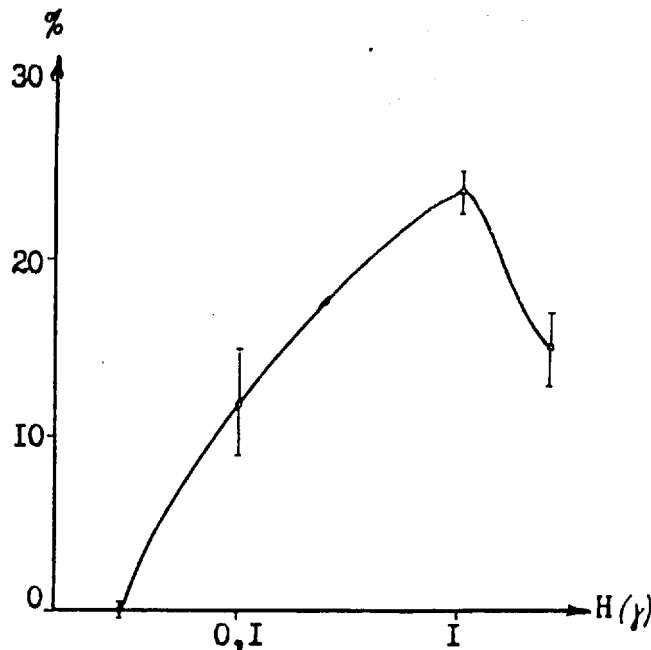

Fig. 3. Correlations between biological effects and field intensity.

Interdependence between biological effects and field intensity

Special experiments were also carried out to examine the dependence of biological effects upon the field intensity for the only one frequency value. An example is presented in fig. 3. In this case only one isolated frequency was used - 8 Hz. The ordinate shows the glycogen concentration in the rabbit's blood. It is clear that growth in the field intensity gives no rise to stronger biological effects. The presence of a certain optimum intensity in some intensity range is clearly seen in these experiments. Thus, the dependence of biochemical or physiological changes upon the field intensity has in general a very complex non-linear form.

It is important to mention that while certain biological and biochemical changes were taking place the minimum field intensity for mammalia was as small as 0.2 nT (with a frequency of 8 Hz and an exposure time of 3 hours). For the electric field the exposure was about 0.1 V/m.

Traditionally, biophysicists have considered specific effects of the electromagnetic field in biological tissue to be hardly possible for such small intensities. However, over the past two decades we have been witnessing growing awareness that very weak alternate electric and magnetic fields do have clear effects on a living organism. Such effects are, of course, hardly explainable in the simplified terms of Joule heating. A new approach to understanding these results is necessary (a number of reviews on this new branch of investigation, i.e. biological action of non-ionising radiation, are available - see /6/).

Conclusion

Our most relevant conclusion is that natural electromagnetic fields within the low frequency - extreme low frequency range should be regarded as an essential factor in ecology. These electromagnetic background fluctuations are closely related to solar activity variations. Thus, the solar activity influence upon medical and biological processes can be explained by taking into account this new ecological agent.

References

1. Gnevyshev, M.N., Ol', A.I. (Eds.): "Effects of Solar Activity on the Earth's Atmosphere and Biosphere". In: Progr. Sci. Transl., Jerusalem, Israel, 1977, 245 p. or In: Moscow, 1971, 224 p. (in Russian).
2. Effects of Solar Activity on Biosphere. In: Problems of Space Biology. Moscow: Nauka, 1982. Vol. 43, 265 p. (in Russian).
3. Clinical and Biophysical Aspects of Heliobiology. In: Problems of Space Biology. Moscow: Nauka, 1988. Vol. 56, 250 p. (in Russian).
4. Sidyakin, V.G., Temurjants, N.A., Makejev, V.B., Vladimirsky, B.M. (1985): "Space Ecology". Kiev: Naukova Dumka, 176 p. (in Russian).
5. Sidyakin, V.G. (1986): "Effects of Global Ecological Factors on the Nervous System". Kiev: Naukova Dumka, 159 p. (in Russian).
6. Temurjants, N.A., Vladimirsky, B.M., Tishkin, O.G. (1989): "Extremely Low Frequency Signals in the World of Biology". Kiev: Naukova Dumka, (in Russian - to be printed).

of
y
ed
ion

in
pe-

m.
mi-
a
of

e
such
t-
tic
e,
g.
of
f

Geo-cosmic relations; the earth and its macro-environment

Proceedings of the First International Congress on
Geo-cosmic Relations, organized by the Foundation for Study
and Research of Environmental Factors (S.R.E.F.),
Amsterdam, 19-22 April 1989

Editors: G.J.M. Tomassen (editor in chief), W. de Graaff,
A.A. Knoop, R. Hengeveld



Pudoc, Wageningen, 1990



CIP data Koninklijke Bibliotheek, Den Haag

Geo-cosmic

Geo-cosmic relations : the earth and its macro-environment : proceedings of the first international congress on geo-cosmic relations, organized by the Foundation for Study and Research of Environmental Factors (S.R.E.F.), Amsterdam, 19-22 April 1989 / eds. G.J.M. Tomassen ... [et al]. - Wageningen : Pudoc

ISBN 90-220-1006-6 geb.

SISO 552 UDC 55:524.8 NUGI 829

Subject heading: geo-cosmology.

© Pudoc, Centre for Agricultural Publishing and Documentation, Wageningen, Netherlands, 1990.

All rights reserved. Nothing from this publication may be reproduced, stored in a computerized system or published in any form or in any manner, including electronic, mechanical, reprographic or photographic, without prior written permission from the publisher, Pudoc, P.O. Box 4, 6700 AA Wageningen, Netherlands.

The individual contributions in this publication and any liabilities arising from them remain the responsibility of the authors.

Insofar as photocopies from this publication are permitted by the Copyright Act 1912, Article 16B and Royal Netherlands Decree of 20 June 1974 (Staatsblad 351) as amended in Royal Netherlands Decree of 23 August 1985 (Staatsblad 471) and by Copyright Act 1912, Article 17, the legally defined copyright fee for any copies should be transferred to the Stichting Reporecht (P.O. Box 882, 1180 AW Amstelveen, Netherlands). For reproduction of parts of this publication in compilations such as anthologies or readers (Copyright Act 1912, Article 6), permission must be obtained from the publisher.

Printed in the Netherlands.

A
P.
B
C
S
M

M
-
- I
- I
U
- F
- F
- I
- F
A
- P
- D
- D
- D
- P
q
- P
S
- R
- D
- D

SREF

Address of the Foundation S.R.E.F.:
P.O. Box 84, 6700 AB Wageningen, The Netherlands.

Board of Directors of the Foundation S.R.E.F.:

Chairman: Drs. W. Beekman
Secretary/Treasurer: Ir. G.J.M. Tomassen
Members: J.S.H.J.W. Bouma
Dr. Ir. E.A. Goewie
Prof. Dr. A.A. Knoop

Members of the International S.R.E.F. Advisory Board

- Prof. Dr. B.G. Cumming, *Dept. of Biology, Univ. of New Brunswick, Canada.*
- Dr. G. Dean, *Subiaco, Western Australia.*
- Prof. Dr. A.P. Dubrov, *Library on Natural Science, Acad. of Sciences, Moscow, U.S.S.R.*
- Prof. Dr. S. Ertel, *Inst. of Psychology, Göttingen University, FRG.*
- Prof. Dr. H.J. Eysenck, *Inst. of Psychiatry, Univ. of London, U.K.*
- Dr. P. Faraone, *Lab. di Igiene e Profilassi, Roma, Italy.*
- Prof. S.J. Kardas Jr., *Laboratorio de Investigaciones Sobre Biorritmos Humanos, La Atlantida, Espana / U.S.A.*
- Prof. Dr. N.V. Krasnogorskaya, *Inst. of the Lithosphere, Moscow, U.S.S.R.*
- Dr. D. Mikhov, *Inst. of Neurology, Psychiatry, Neurosurgery, Sofia, Bulgaria.*
- Dr. B. Primault, *Agro- and Bio-meteorologist, Zürich, Switzerland.*
- Dr. M.F. Ranky, *Central Research Inst. of Physics, Budapest, Hungary.*
- Prof. Dr. J.P. Rozelot, *Centre d'études et de recherches geo-dynamique et astronomique, Grasse, France.*
- Prof. Dr. P.A.H. Seymour, *Dept. of Marine Science and Technology, Polytechnic South West, Plymouth, U.K.*
- R. Swenson, *Director of the Center for Study of Complex Systems, New York, U.S.A.*
- Dr. N.V. Udaltsova, *Inst. of Biophysics, Moscow, U.S.S.R.*
- Dr. T. Zeithamer, *Geophysical Inst., Acad. of Sciences, Praha, Czechoslovakia.*

natio-
nch of
[et al].

lands,

erized
repro-
doc,

in the

le 16B
lands
gally
recht
ation
must

Contents

Editorial introduction, conclusions and remarks – <i>Ir. G.J.M. Tomassen, editor and secretary-treasurer of the Foundation for Study and Research of Environmental Factors (SREF)</i>	1
Opening Address by the Rector of the University of Wageningen – <i>Prof. Dr. H.C. van der Plas</i>	3
Opening Speech by the Chairman of the Congress – <i>Prof. Drs. J.D. van Mansvelt, Dept. of Ecological Agriculture, Wageningen University</i>	5
Introductory papers	9
Dynamics of the solar system – <i>W. de Graaff</i>	11
Radiation in our environment, from the atmosphere and from space – <i>E. Wedler</i>	17
Biological cyclicity in relation to some astronomical parameters: a review – <i>B.G. Cumming</i>	31
Biological clocks and the role of subtle geophysical factors – <i>H.M. Webb</i>	56
Man in a rhythmic universe – <i>A.A. Knoop</i>	65
Water as receptor of environmental information: a challenge to reproducibility in experimental research. The Piccardi scientific endeavour – <i>C. Capel-Boute</i>	75
Application to climatic variations of the energy transfer between the earth and the sun: the new concept of helioclimateology – <i>J.P. Rozelot</i>	92
The earth and its macro-environment, a multi-disciplinary approach	103
The possible influence of some astro-physical factors on micro-organisms – <i>P. Faraone</i>	105
Lunar cycle and nuclear DNA variations in potato callus or root meristem – <i>M. Rossignol, S. Benzine-Tizroutine and L. Rossignol</i>	116
Cellular effects of low level microwaves – <i>W. Grundler</i>	127

al Gardens

t)

te of
ansvelt,
ldeman,
., retired

de
i; Prof.
r. B.C.J.
the

s”

mental

rtment of

Quantitative evaluation of the geomagnetic activity – <i>D. Mikhov</i>	135	Po
Ovulation and seasons - Vitality and month-of-birth – <i>P.H. Jongbloet</i>	143	dis
Note on human response to the lunar synodic cycle – <i>N. Kollerstrom</i>	157	Ga
Influence of abiotical ecological factors on daily rhythm activity of mitochondrial and lysosomal ferments of blood leucocytes in human ontogenesis – <i>N. Kacergiené, N. Dailidienė and R. Vernickaite</i>	161	Intr Ro
ELF electromagnetic fields as a new ecological parameter – <i>N.A. Temuryants, V.G. Sidyakin, V.B. Makejev, B.M. Vladimirsky</i>	169	Eff The
The possible gravitational nature of factors influencing discrete macroscopic fluctuations – <i>N.V. Udaltsova, V.A. Kolombet and S.E. Shnoll</i>	174	The
Macroscopic fluctuations with discrete structure distributions as a result of universal causes including cosmophysical factors – <i>S.E. Shnoll, N.V. Udaltsova and N.B. Bodrova</i>	181	Bioi The to a
Geo-cosmic relations and some aspects of their realization – <i>N.V. Krasnogorskaya and G.Ya. Vasilyeva</i>	189	Resc and s
Influence of solar activity on ELF sferics of 3 Hz range – <i>I. Örményi</i>	198	Nonl funct
Links between moon phases and ELF atmospherics of 3 Hz range – <i>I. Örményi</i>	206	Struc
Possible influence of equinoxes and solstices on ELF sferics of 3 Hz. range – <i>I. Örményi</i>	210	Geo- matte
Analysis of weak magnetic field effects of the Piccardi test and Belousov-Zhabotinsky reaction – <i>L.P. Agulova, A.M. Opalinskaya</i>	214	An at screen
Relationships between the electromagnetic VLF-radiation of the atmosphere and chemical as well as biochemical processes – <i>J. Eichmeier and H. Baumer</i>	223	Unde of rea
Periodicities of meteorological parameters at Schiermonnikoog. A simple explanation – <i>H.F. Vugts</i>	233	Abstr
Mars and temperature-changes in the Netherlands: an empirical study – <i>J.W.M. Venker and M.C. Beeftink</i>	240	How c Basis c

135	Possible planetary effects at the time of birth of successful professionals: a discussion of the 'Mars-effect' – <i>M. Gauquelin</i>	246
143	Gauquelin's contentions scrutinized – <i>S. Ertel</i>	255
157	Introversion-Extraversion; sunsign-effect and sunsign-knowledge – <i>J.J.F. van Rooij, M.A. Brak and J.J.F. Commandeur</i>	267
161	Effect sizes of some pre-scientific geo-cosmic theories – <i>G. Dean</i>	272
169	Theoretical and background contributions	279
174	The changing concept of physical reality – <i>J. Hilgevoord</i>	281
181	Biological order – <i>E. Schoffeniels</i>	291
189	The earth as an incommensurate field at the geo-cosmic interface: fundamentals to a theory of emergent evolution – <i>R. Swenson</i>	299
198	Resonant magneto-tidal coupling between the components of the solar system and some of its terrestrial consequences – <i>P.A.H. Seymour</i>	307
206	Nonlinear dynamics and deterministic chaos. Their relevance for biological function and behaviour – <i>F. Kaiser</i>	315
210	Structural stability of the earth's magnetosphere – <i>T. Zeithamer</i>	321
214	Geo-solar-cosmic electric relations in electrostatics with field E screening by matter – <i>L.A. Pokhmelnikh</i>	327
223	An attempt of interpretation of Piccardi chemical tests. Effects of metallic screens – <i>L. Boulanger, R. Chauvin</i>	336
233	Understanding geo-cosmic relations: some philosophical remarks on the nature of reality – <i>T. Saat</i>	343
240	Abstracts	351
	How does man fit into nature? – <i>R. Augros, G. Stanciu</i>	353
	Basis of judgement for geo-cosmic relations – <i>H.J. Eysenck</i>	353

Correlation of hospital mortality with the phases of the tidal variations of gravitation – <i>W. Raibstein</i>	354	List
The time course of the elimactic syndrome and the role of geographical factors – <i>I.V. Verulashvili</i>	354	List
Changes in the earth's rate of rotation – <i>A. Poma, E. Proverbio</i>	354	
On the problems of the effect of the sun and planetary system on meteorological disturbances in the atmosphere – <i>K. Kudrna</i>	355	
The role of the geomagnetism (GMF) and gravity (GRF) in creating fundamental peculiarities of living beings – <i>A.P. Dubrov</i>	355	
Cycles in the history of forestry – <i>J. Buis</i>	356	
Cosmic and environmental influences on plants, testing of sowing calendar on beans (<i>Phaseolus vulgaris</i>) in Brazil. Research done in this area until today and its future implications in agriculture – <i>A. Harkaly</i>	356	
Modifications of the growth of seedling roots versus time on a scale of copper sulphate solutions – <i>E. Graviou</i>	357	
Dynamic responses tests quantifying complex properties of plants: how living structures could reveal their geo-cosmic past – <i>M.F. Ranky</i>	358	
A dynamic biological-atmospheric-cosmic energy continuum: some old and new evidence – <i>J. DeMeo</i>	358	
Solar-terrestrial factors and ontogenesis (clinical experimental tests) – <i>R.P. Narcissov, S.V. Petrichuk, V.M. Shishchenko, Z.N. Duchova and G.F. Suslova</i>	358	
Statistical identification of the planetary modulation of the solar activity by the determination of third order moments and the estimation of the volterra kernels – <i>C. Gaudeau, E. Daubourg and P. David</i>	359	
• Geocosmic bonds in anomal human behaviour – <i>A.N. Kornetov</i>	359	
Macroscopic fluctuations as a fundamental physical phenomenon – <i>V.A. Kolombet</i>	360	

TAB

Resonance Effect of Microwaves on the Genome Conformational State of *E. coli* Cells

Igor Ya. Belyaev, Yevgeny D. Alipov, Victor S. Shcheglov, and Vitaly N. Lystsov
 Moscow Engineering Physics Institute, Kashirskoye Shosse, 31, Moscow, 115409, C.I.S.
 Temporary Research Collective "Otklik", Vladimirskaia st., 61 "B",
 Kiev, GSP, 252017, C.I.S.

Z. Naturforsch. 47c, 621-627 (1992); received September 21, 1990/January 1, 1992

Cellular Biology, Microwave Bioaction, Radiation Damage, Repair

The effect of low intensity microwaves on the conformational state of the genome of X-irradiated *E. coli* cells was studied by the method of viscosity anomalous time dependencies. It has been established that within the ranges of 51.62-51.84 GHz and 41.25-41.50 GHz the frequency dependence of the observed effect has a resonance nature with a resonance half-width of the order of 100 MHz. The power dependence of the microwave effect within the range of 0.1-200 $\mu\text{W}/\text{cm}^2$ has shown that a power density of 1 $\mu\text{W}/\text{cm}^2$ is sufficient to suppress radiation-induced repair of the genome conformational state. The effect of microwave suppression of repair is well reproduced and does not depend on the sequence of cell exposure to X-rays and microwave radiation in the millimeter band. The results obtained indicate the role of the cell genome in the resonant interaction of cells with low intensity millimeter waves.

Introduction

At present a significant body of evidence has been collected on the ability of microwaves in the millimeter range to bring about biological effects including those on the cellular level [1, 2]. It has been found that microwaves can influence the processes of gene expression [3-5]. The specific features of such interaction are dependence on frequency and also effectiveness of low intensity microwave radiation which does not result in significant heating of the irradiated object. One of the possible explanations of these facts accounts for the influence of millimeter waves on the genome conformational state [6]. The genome conformational state (GCS) is expressed as the space-topological organization of the entire chromosomal DNA, which is ensured, among other things, by the supercoiling of DNA and DNA protein bonds. The GCS changes play a significant role in all elementary genetic processes - transcription, replication, repair.

The hypothesis which accounts for the influence of millimeter radiation most evident in the case of stressed systems [1, 7] among them bioobjects sub-

jected to ionizing radiation [6] has repeatedly been verified.

The influence of millimeter waves on the process of the GCS repair after *E. coli* K 12 cell exposure to X-rays was examined in this work. As a test for appearance and repair of changes in a chromosomal DNA we used the method of the anomalous viscosity time dependencies (AVTD) in cell lysates [6].

Materials and Methods

Microwave and X-ray irradiation

A block diagram of the experimental unit used for microwave irradiation of cell suspension is given in Fig. 1. A G4-141 generator served as the source of extremely high frequency electromagnetic radiation (EHF EMR). In the course of irradiation

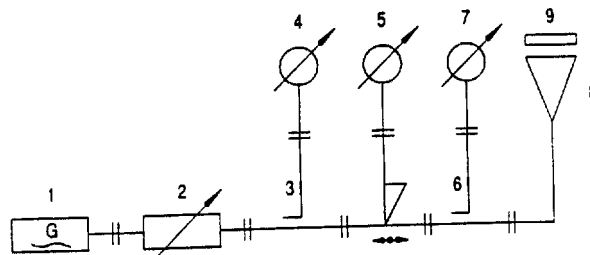

Fig. 1. Block diagram for microwave irradiation of cell suspension: 1 - EHF EMR generator; 2 - controlled attenuator; 3, 6 - directional coupler; 4 - frequency analyzer; 5 - measurement coupler; 7 - power meter; 8 - pyramidal horn; 9 - cell suspension.

Reprint requests to I. Ya. Belyaev, Moscow Engineering Physics Institute, Kashirskoye sh., 31, Moscow, 115409, C.I.S.

Verlag der Zeitschrift für Naturforschung.
 D-W-7400 Tübingen
 0939-3075/92/0700-0621 \$ 01.30/0

622 I. Y. Belyaev *et al.* · Resonance Effect of Microwaves on the Genome Conformational State of *E. coli* Cells

tion the frequency, the output power, as well as the voltage standing wave ratio (VSWR) were controllable. Frequency instability was 1 MHz, error in the measurement of the output power did not exceed 10% and the value of VSWR in the waveguide was not more than 1.6. Irradiation of a cell suspension (1.5 mm thickness) was carried out in Petri dishes, 50 mm in diameter, by means of a pyramidal horn having dimensions $40 \times 50 \text{ mm}^2$.

The space distribution of the power density (PD) on the surface of the suspension was measured by means of a dipole EHF probe [8]. With the irradiation frequencies used the local PD values at the surface of the suspension differed by nearly an order of magnitude. But frequency changes of $\pm 200 \text{ MHz}$ did not lead to significant changes of the pattern of PD distribution. At the same time frequency changes in a wide range (of the order of units GHz) could lead to a marked displacement of PD minima and maxima up to their inversion. In the event of parity of output power in the waveguide, the PD value, averaged over the whole surface under irradiation, did not change.

The specific absorption rate (SAR) was measured in two ways: by the acoustic method [9] and the calorimetric method. The suspension temperature was measured by a microthermocouple.

Cells were subjected to X-rays (XR) using a radiological unit RUP-150. The distance from the focus to the suspension was 40 cm, average radiation energy - 50 keV, dose rate 0.7 Gy/min. Microwave and X-irradiation of cells was carried out at ambient temperature.

Preparation of bacterial cells for experiments and cell lysis

The following strains were used in the work: *E. coli* K12: AB1157 F^- thr-1 ara-14 leu-B6 proA2 lacGI tsx-33 supE44 galK2 hisG4 rfbDI mgl-51 rpsL31 xyl-5 mtl-1 argE3 thi-1 λ^- rac $^-$; G62 F^+ proA23 lac-28 trp-30 his-51 rpsLR and also strain RM117 which is isogenic with strain AB1157. Cells were cultivated by standard methods in Luria broth or minimal medium M-9 [10]. The *E. coli* cultures used in the experiments were kept in spreadings on the Hottinger nutrient agar at 3-4 °C.

Before irradiation, cells from the night culture were resuspended in concentrations of $3 \div 9 \times 10^7$

cells/ml in a salt buffer M-9. Cells were kept under these conditions for 1 h before irradiation.

After irradiation, cells were lysated by gradually adding LET-lysozyme (LET-medium: 0.5 M $\text{Na}_2 \text{EDTA}$, 0.01 M Tris-HCl, pH 7) in a concentration of 3 mg/ml. LET-sarcosyl (2%) and LET-papain (3 mg/ml) with 10 to 15 min intervals between addition of each agent. 0.3 ml LET-lysozyme, 1.0 ml LET-sarcosyl, 0.7 ml LET-papain were added to 1 ml of cell suspension. The lysates were then kept in darkness at a temperature of 30 °C for 40 h, after that the AVTD were measured.

Method of anomalous viscosity time dependencies

This method is based on the fact that in solutions of high-polymer DNA, placed in a rotary viscosimeter, radial migration of DNA, which is a directed movement of macromolecules towards the inner cylinder of the viscosimeter (rotor), is observed [11].

Measurements were carried out in a rotary cylindrical viscosimeter with an automatic record of the rotor's rotation period [6]. In the unit used, the rotor was set in motion by a constant moment of force created by an external electromagnetic field.

Upon completion of the lysis the rotor was suspended on the meniscus of the lysate examined. Thereafter the lysate was placed in a thermostatically controlled (30 °C) jacket of the viscosimeter for measurement.

When the external electromagnetic field is switched on, the rotor starts moving. In the initial stage of measuring the rotor's rotation period (T), the lysate viscosity increases due to a radial migration of macromolecules. This results in an increased rotation period of the rotor since the period is proportional to the specific viscosity (Fig. 2, curve 1). After the DNA macromolecules had deposited on the external surface of the rotor the velocity of its rotation decreased to the value typical of a pure solvent. The dependence of the rotor's rotation period in the cell lysate on the time after the rotor's rotation starts (t) is called anomalous viscosity time dependence.

It should be noted here that AVTD cannot be observed in protein solutions, because radial migration doesn't take place in solutions of molecules with weights less than 10^6 D [11]. The param-

eters of the AVTD curve in the cell lysate are determined by the genome conformational state, i.e. by hydrodynamic parameters of chromosomal DNA macromolecules which in their turn depend on the DNA nativity, DNA association with various proteins, the microenvironment, etc. The rotor's maximum rotation period (T_{max}) which in this method is the most sensitive parameter characterizing the genome conformational state of *E. coli* cells, was obtained from the AVTD curve. The measurement error of the rotor's rotation period was 2%.

Results

Irradiation of *E. coli* cells with doses of 10–50 Gy leads to changes of the AVTD curve of the cell lysate (Fig. 2, curve 2). The major cause of these changes is the considerable decrease of T_{max} . After post-irradiated cell incubation for 90–120 min, depending on the dose of irradiation, an almost complete recovery of the AVTD curve (Fig. 2, curve 3) took place. This means that during this period the GCS of the irradiated cells returned to the control level. It is in this sense that we use the term "repair" of the genome conformational state. In preliminary experiments the X-irradiated cells were exposed to microwaves in the regime of frequency switching. This was brought about within the range of about 200 MHz during 30–90 min. Fig. 2 (curve 4) shows the AVTD curve after cell

irradiation within the frequency band of 51.60–51.78 GHz at PD = 3 mW/cm² for 90 min.

It can be seen that microwaves in this range effectively suppress repair of the GCS. To assess the microwave effect on the repair process after X-irradiation, we used the following ratio:

$$\kappa = \frac{\bar{T}_{max\ XR + I} - \bar{T}_{max\ eff}}{\bar{T}_{max\ XR + I} - \bar{T}_{max\ XR}}$$

where:

$\bar{T}_{max\ XR}$ – the average maximum rotor's rotation period in the lysates of cells lysated immediately after X-irradiation;

$\bar{T}_{max\ XR + I}$ – the average maximum rotor's rotation period in the lysates of cells lysated after X-irradiation and subsequent incubation (I);

$\bar{T}_{max\ eff}$ – the average maximum rotor's rotation period in the lysates of cells subjected to EHF EMR during the radiation-induced repair. In two effective microwave ranges the κ dependencies on frequency were determined.

In these experiments, cells were irradiated with microwaves of a certain frequency for 5 to 15 min after X-irradiation. To assess the average value of the rotor's maximum rotation period (\bar{T}_{max}) in each of the experiments 3 AVTD measurements were made. Significance level was determined by the Student's t-test. The extent and results of a standard experiment are given in Table I.

Fig. 3 and Fig. 4 present the κ dependence in the ranges examined: 51.62–51.84 GHz (strain

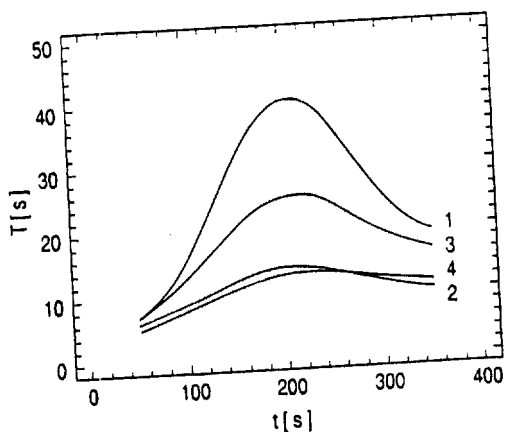

Fig. 2. Anomalous viscosity time dependencies of *E. coli* G62 cell lysates: 1 – control; 2 – X-irradiation (30 Gy); 3 – XR and incubation (90 min); 4 – XR and incubation under the influence of EHF EMR.

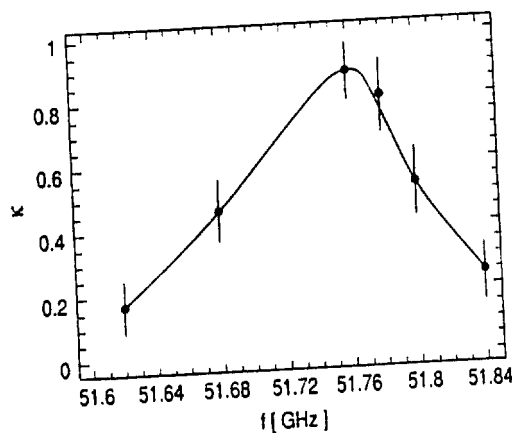

Fig. 3. Frequency dependence of EHF EMR effect on radiation-induced repair of the GCS of *E. coli* RM117 cells (20 Gy; 15 min; 3 mW/cm²).

Table I. Values of the maximum rotor's rotation period derived from AVTD curves obtained in lysates of *E. coli* AB1157 cells, lysated after X-irradiation (20 Gy), subsequent incubation or irradiation with EHF EMR (200 $\mu\text{W}/\text{cm}^2$) in the course of incubation.

Type of effect	EMR frequency [GHz]	Duration of EHF EMR irradiation [min]	T_{max} [S]	$\bar{T}_{\text{max}} \pm \text{SE}^*$ [S]	Significance level as compared with XR + I
Control	-	-	51.1	44.8 \pm 4.8	p < 0.03
			35.1		
			47.8		
XR	-	-	7.4	7.0 \pm 0.3	p < 0.0001
			7.2		
			6.5		
XR + I	-	-	28.1	26.2 \pm 1.0	-
			24.7		
			25.7		
XR	41.25	10	14.0	12.8 \pm 0.6	p < 0.0004
			12.3		
			12.1		
XR	41.30	10	7.2	6.9 \pm 0.3	p < 0.0001
			6.4		
			7.2		
+	41.35	10	8.9	9.7 \pm 0.4	p < 0.0002
			10.1		
			10.1		
EMR	41.40	10	9.7	11.0 \pm 0.7	p < 0.0004
			11.2		
			12.2		
+	41.45	10	16.2	16.7 \pm 0.3	p < 0.001
			17.3		
			16.6		
I	41.50	10	15.2	15.6 \pm 0.3	p < 0.0006
			16.2		
			15.6		

* Standard error.

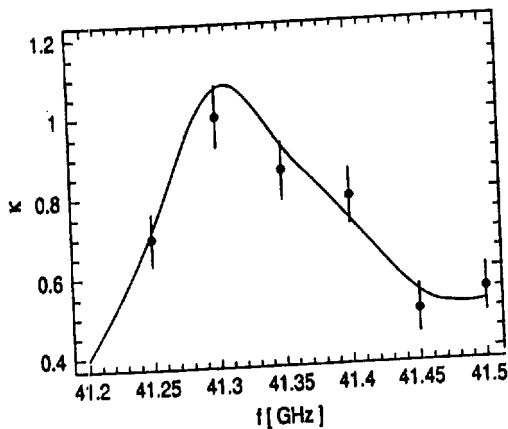

Fig. 4. Frequency dependence of EHF EMR effect on radiation-induced repair of the genome conformational state of *E. coli* AB1157 cells (20 Gy; 200 $\mu\text{W}/\text{cm}^2$, 10 min).

RM117) and 41.25–41.50 GHz (strain AB1157). It is clear that in both ranges this dependence has a resonance nature with a resonance half-width of the order of 100 MHz and resonance frequencies of 51.76 GHz and 41.32 GHz respectively. In the first instance the cell exposure to EHF EMR was carried out at PD = 3 mW/cm². The SAR value, estimated by acoustic and calorimetric methods, amounted to 17 mW/g and 22 mW/g respectively. Heating of the cell suspension, when irradiated, did not exceed 1 °C. The x dependence on frequency within the range of 41.25–41.50 GHz was studied at PD = 200 $\mu\text{W}/\text{cm}^2$ with heating not exceeding 0.1 °C. It should be noted that heating of a cell suspension by 5 °C for 10 min right after the X-irradiation did not lead to suppression of repair

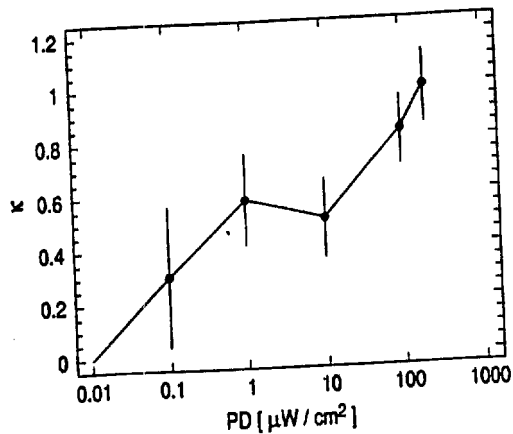

Fig. 5. Dependence of suppression effectiveness of radiation-induced GCS repair on microwave PD (strain AB1157, 20 Gy; 41.32 GHz, 5 min).

processes. We also studied the dependence of suppression of radiation-induced GCS repair on PD of the microwave exposure at the 41.32 GHz frequency. The power dependence of α is shown in Fig. 5. Starting with a PD of $1 \mu\text{W}/\text{cm}^2$, irradiation for 5 min significantly suppressed GCS repair.

As pointed out above, Fig. 3 shows a frequency dependence within the 51.62–51.84 GHz range for RM117 strain. But this microwave irradiation was effective in repair suppression for the other strains used: AB1157 and G62. Altogether 11 experiments were carried out, each revealing statistically significant suppression of repair processes by microwaves at frequencies of this resonance.

An EHF EMR effect on the genome conformational state was also discovered in the case of inverse sequence of cell exposure to microwaves and X-rays. Irradiation of cells with EHF EMR at the 51.78 GHz frequency (that is close to that of resonance) before X-irradiation prevented the process of radiation-induced repair (Table II).

Table II. Values of the maximum rotor's rotation period in cell lysates after a combined effect EHF EMR ($3 \text{ mW}/\text{cm}^2$, 51.78 GHz, 30 min) and XR (30 Gy) on *E. coli* RM117 cells.

Type of effect	$\bar{T}_{\text{max}} \pm \text{SE}$ [S]	Significance level as compared with XR + I
Control	17.1 ± 0.9	$p < 0.04$
XR	6.9 ± 0.1	$p < 0.02$
XR + I	12.5 ± 1.4	—
EMR + XR + I	7.2 ± 0.2	$p < 0.003$

Discussion

It is generally accepted that biological membranes are receptors of chemical and electromagnetic signals. Can this premise alone explain those resonance bioeffects which can be seen when cells are subjected to low-intensity millimeter radiation? This resultant effect can change such important biological parameters as velocity of cell division [1, 2] or processes of gene expression [3, 5]. It would seem that the simplest answer to the question of the target of microwave resonance effect is that the target is the cell membrane whose properties determine frequencies of resonant interaction. Indeed, in a number of model studies microwave effects were detected that had been caused by a change in the ion membrane transport [13–15]. But the microwave “membrane” effects examined did not depend on the EMR frequency and therefore do not permit explanation of the resonance effect on the processes of cell development and gene expression. It appeared to us that a promising explanation of these observations could be supplied by the notion of the role of the genome conformational state in forming cell's resonance response to the millimeter wave exposure. In other words, we assumed that parameters of the GCS, *i.e.* space-topological organization of chromosomal DNA, determine resonance frequencies. In such an event the GCS would be sensitive to the effect of millimeter waves of certain frequencies.

In order to provide support for this supposition we used the method of anomalous viscosity time dependencies in cell lysates, which has a high sensitivity to the GCS change [6]. Changes in the AVTD can be detected even with an X-ray dose of 10 cGy when less than one single-strand DNA break is induced per *E. coli* genome. This result already made it possible to assume that the AVTD method is sensitive not only to damages of the sugar-phosphate bonds of the DNA secondary structure. The AVTD sensitivity to other changes of the genome conformation, particularly those caused by DNA-protein bonds, was confirmed by the experiments we carried out [16]. The results obtained in the course of our work indicate that repair of the genome conformational state of bacterial cells after ionizing irradiation is highly sensitive to the resonance effect of millimeter waves.

The microwave effect discovered cannot be explained by trivial heating. This was borne out by

626 I. Y. Belyaev *et al.* · Resonance Effect of Microwaves on the Genome Conformational State of *E. coli* Cells

many of the results obtained. First, there were effective PD of about $1 \mu\text{W}/\text{cm}^2$, while SAR amounted to $10 \mu\text{W}/\text{g}$ is not enough for a noticeable heating of the irradiated suspension over 5–15 min. Second, heating of the cell suspension by 5°C for 10 min during the postradiative incubation has no influence on the restoration. Finally, the PD averaged over the irradiated surface did not depend on the frequency within the limits of the observed resonances (± 200 MHz).

There is hardly any doubt that destabilization of repair and probably other protein complexes with DNA is the central event of the molecular-biological mechanism preventing the GCS repair. Surprisingly, this effect may be obtained even if cells are subjected to EMR with resonance frequency before X-irradiation. This result means that a cell, irrespective of whether or not it was X-irradiated, retains the microwave resonance effect for a certain period. It is especially important to stress that this memory is realized at the level of the genome conformational state. This inference is supported by the fact that after a 5–10 min EMR effect on X-irradiated cells, the prevention of GCS repair persists for at least an hour and a half of the subsequent incubation.

The discovered frequency dependence of the effect, especially the half-width of resonances (100 MHz), is similar in character to that which had been obtained when studying the gene expression of repressed λ -prophage operon in lysogenic *E. coli* cells [3, 5]. In our view, this coincidence is one more argument in favour of the supposition of the role of the genome conformational state in the resonance response of bacterial cells to a millimeter wave effect.

In general, a chain of events seems to be involved in this interaction. At the first stage, microwaves interact with cell membranes. It is likely that the signal in the membrane intensifies and is received in the DNA through the point (points) where DNA is attached to the membrane. We believe that there are parameters of DNA or its selected sites, including those bound with proteins, that determine the resonance frequencies of electromagnetic waves capable of influencing the genome conformational state through the membrane.

One cannot exclude the possibility that the primary targets of millimeter wave action are proteins, which take part in maintaining the structural

and functional integrity of chromosome DNA [18, 19]. Then changes in the GCS registered by the AVTD method will be defined by the influence of EHF EMR on the function of these proteins. By affecting the GCS through the processes of molecular interaction the microwaves may give rise to changes of DNA secondary structure, changes in elementary genetic processes: transcription, replication, repair and recombination. Consequently, it is possible to record the final biological effect at the cell level: modification of gene expression down to derepression of operons [2–5], changes in the velocity of DNA synthesis and in cell division [1, 17].

It is worth noting that cells of all the *E. coli* strains used (AB1157, RM117, G62) were sensitive to EMR of the 51.62–51.84 GHz frequency band. The first two of these strains are isogenic by known markers. As to the third strain, it differs from the previous ones by a number of markers. For instance, G62 cells have no mutations in the gene of acetylornithine deacetylase or other genes whose products take part in the biosynthesis of arginine and therefore are not auxotrophic on this amino acid. It is possible that structural genes whose mutations determine differences in the strains used have no relationship with a mechanism of resonance interaction. But it appears likely to us that resonance frequencies are determined by regulatory nucleotide sequences and their mutual position within cellular DNA.

The results obtained in this work are in accordance with the physical models predicting the existence in living systems of discrete resonance states corresponding to the millimeter band of an electromagnetic field [18, 19].

A further experimental confirmation of the genome's role in giving rise to these discrete states and the existence of selection rules on helicity for transitions between them will be made public at a later date.

Acknowledgements

The authors express their gratitude to O. A. Aizenberg for providing strains and to V. M. Shtemler for assistance in SAR measurements. They are also sincerely grateful to W. Grundler, F. Keilmann and S. P. Sitko for discussing the results of this work.

- [1] W. Grundler, U. Jentzsch, F. Keilmann, and V. Putterlic, in: *Biological Coherence and Response to External Stimuli* (H. Frohlich, ed.), pp. 65–85, Springer Verlag, Heidelberg 1988.
- [2] E. Postow and M. L. Swicord, in: *CRC Handbook of Biological Effect of Electromagnetic Fields* (C. Polk and E. Postow, eds.), pp. 425–460, CRC Press, Inc., Boca Raton 1986.
- [3] S. J. Webb, *Phys. Lett.* **73A**, 145 (1979).
- [4] F. Kremer, C. Koschnitzke, L. Santo, P. Quick, and A. Poglitsch, in: *Coherent Excitation in Biological Systems* (H. Frohlich and F. Kremer, eds.), pp. 10–20, Springer Verlag, Berlin 1983.
- [5] K. V. Lukashevsky and I. Ya. Belyaev, *Med. Sci. Res.* **18**, 955 (1990).
- [6] Ye. D. Alipov, I. Ya. Belyaev, D. I. Yedneral, D. M. Izmailov, K. V. Lukashevsky, L. K. Obukhova, O. V. Okladnova, and V. S. Shcheglov, in: *Proceedings of the Workshop on Genetic Effects of Charged Particles* (K. G. Amirtaev and S. Kozubek, eds.), pp. 150–160, JINR, Dubna 1989 (in Russian).
- [7] S. P. Sitko, E. A. Andreev, and I. S. Dobronravova, *J. Biol. Phys.* **16**, 71 (1988).
- [8] G. T. Butkus, K. K. Mikalauskas, and A. S. Pausha, in: *Medicobiological Aspects of Millimeter Radiation* (N. D. Devyatkov, ed.), pp. 230–234, IRE Ac. Sci. U.S.S.R., Moscow 1987 (in Russian).
- [9] I. G. Polnikov and A. V. Putvinsky, *Biofizika* **33**, 893 (1988) (in Russian).
- [10] J. Miller, *Experiments in Molecular Genetics*, p. 373, Mir, Moscow 1976 (in Russian).
- [11] E. L. Uhlenhopp, *Biorheology* **12**, 137 (1975).
- [12] V. D. Iskin, Yu. V. Zavgorodny, N. M. Yatsenko, L. K. Silina, E. V. Stepula, A. W. Medvedovsky, B. G. Rice, and S. V. Rudenko, *Biological Effects of Millimeter Waves. Review. A. Deposited Manuscript*, p. 75, All-Union Institute of Scientific and Technical Information of the U.S.S.R., Moscow 1987 (in Russian).
- [13] V. M. Shtemler, in: *The All-Union Symposium with Foreign Participants: Theoretical and Applied Aspects of Usage of the Millimeter Electromagnetic Irradiation in Medicine. Abstracts* (S. P. Sitko, ed.), pp. 114–115, TRC "Otklik", Kiev 1989 (in Russian).
- [14] R. N. Khramov, Ye. M. Kobrinsky, A. K. Filippov, and N. I. Porotikov, *ibid.*, pp. 49–50 (in Russian).
- [15] I. Yu. Petrov and O. V. Betsky, *Dokl. Acad. Nauk U.S.S.R.* **305**, 474 (1989) (in Russian).
- [16] Ye. D. Alipov, I. Ya. Belyaev, V. P. Kryuchkov, and V. N. Lystsov, in: *Proceedings of the Eight Balkan Biochemical and Biophysical Days*, pp. 1–2, Institute of Atomic Physics, Bucharest 1990.
- [17] I. Ya. Belyaev, Ye. D. Alipov, V. S. Shcheglov, K. V. Lukashevsky, and V. N. Lystsov, in: *Proceedings of Tenth International Biophysics Congress*, p. 549, Vancouver 1990.
- [18] S. P. Sitko, V. I. Sugakov, *Dokl. Acad. Nauk Ukr. S.S.R.* **6 B**, 63 (1984) (in Russian).
- [19] F. Keilmann, *Z. Naturforsch.* **41 c**, 795 (1986).

TAB

7. Molecular-Biological and Cytological Aspects of Lympholeukaemia (in Russian) (Eds. N. Nikolayeva and others) Nauka, Moscow, 1981
8. FEOFANOVA, T. V. *et al.*, Mathematical Biophysics (in Russian) pp. 50-59, Kras. State Univ. Krasnoyarsk, 1985

Biophysics Vol. 33, No. 2, pp. 376-377, 1988
Printed in Poland

0006-3509/88 \$10.00
© 1989 Pergamon Press

FREQUENCY RANGE OF THE AUDITORY EFFECT OF U.H.F.*

R. E. TIGRANYAN and V. V. SHOROKHOV

Institute of Biological Physics, U.S.S.R. Academy of Sciences, Pushchino (Moscow Region)

(Received 5 August 1986)

The zero beats of radiosound of an acoustic signal from an electrodynamic emitter over the frequency range to 8 kHz have been recorded for the first time in a natural experiment. It is shown that the zero beats between the acoustic tonal signal and the first harmonic of the pulse sequence of u.h.f. are fixed most clearly at the points corresponding to low threshold values in the threshold curve of the u.h.f. auditory effect.

IN [1] concerned with determination of the boundaries of the frequency range of radiosound perceived by humans it was shown that it is limited downwards by the value 8 kHz and upwards by the intrinsic high-frequency boundary of hearing (h.f.b.h.) of the subjects. However, our findings [3, 4] obtained in various physical models pointed to the possibility, in principle, of human perception of the whole sound range and not a part of it. In particular, this followed from experiments on a two-contour resonance model based on the most fundamental principles known from the theory of hearing. The proposed two-contour model fully reflects the mechanisms of hearing and is in line with the existing analogues of these mechanisms, isolates the first harmonic absent in the signal without conflicting with the physiological and neurophysiological data. Thus, the absence of residual sound [2] in the preresonance region in the natural experiment [1] may be explained by the following factors.

1. Insufficient attention of the subjects during the experiment to establish the presence of beats at low frequencies.
2. The high level of noise (~40 dB above the hearing threshold) in a room where the natural experiment was run.
3. The low amplitude of the frequency of the beats at the mean level at low repetition frequencies of the u.h.f. pulses.
4. The insufficient power of the u.h.f. pulse taking into account the fact that with fall in the repetition frequency of the u.h.f. pulses the threshold rises.

* Biofizika 33: No. 2, 349-350, 1988.

Since rise in power in the
to detect the beats in the p
lower noise level (~20 dB)
rectangular waveguide of
Thus the density of the flu
region of the head was irr
u.h.f. pulses chosen was u
through earphones of a G
and the frequency of the to
meters being controlled w
At a repetition frequen
by one subject. Starting fro
further increase in the repe
scently perceived over the w
an acoustic tonal signal in o
where perception in the op
these frequencies were 3-58,
kHz and for the third 3-80,
recorded zero beats in a ton

TYAZHELOV, V. V., *et al.*
SCHOUTEN, J. F., Proc. K

TIGRANYAN, R. E. and SH
In: Biological Effect o
(in Russian) ONTI NTs

Biophysics Vol. 33, No. 2, pp. 377-382, 19
Printed in Poland

DISTRIBUTION
(¹³C) II

Institute of Molecula

question of the reasons for
is considered. Analysis of
indicate that the differences
Biofizika 33: No. 2, 351-355.

Since rise in power in the pulse is not without danger we carried out the experiment to detect the beats in the preresonance region (1-7 kHz) in conditions of a substantially lower noise level (~ 20 dB). Irradiation was at a carrier frequency of 800 MHz using a rectangular waveguide of section 150×270 mm², the power in the pulse ~ 120 W. Thus the density of the flux of power (d.f.p.) in the pulse was 0.6 W/cm². The parietal region of the head was irradiated as in the previous experiments. The duration of the u.h.f. pulses chosen was up to 25 μ sec. The tonal signal was delivered to the subject through earphones of a GS-100I generator. The repetition frequency of the pulses and the frequency of the tonal acoustic signal varied from 1 to 7 kHz, both these parameters being controlled with a ChZ-34 frequency meter.

At a repetition frequencies of the pulses of 1-3 kHz the sound was perceived only by one subject. Starting from 3 kHz the sensation of sound became more intense. With further increase in the repetition frequency of the u.h.f. pulses the sound was confidently perceived over the whole range by all the subjects. The presence of beats with an acoustic tonal signal in order to shorten the radiation time was checked at the points where perception in the opinion of the subjects was most distinct. For the first subject these frequencies were 3.58, 4.21, 5.23 and 6.99 kHz, for the second 4.01, 5.33 and 6.99 kHz and for the third 3.80, 4.74 and 4.97 kHz. At these frequencies all subjects clearly recorded zero beats in a tonal acoustic signal.

REFERENCES

1. TYAZHELOV, V. V., *et al.*, Radioscience 14: 259, 1979
2. SCHOUTEN, J. F., Proc. Koninklijke Nederlandse Akademie van Wetenschappen 43: 356, 1985
3. TIGRANYAN, R. E. and SHOROKHOV, V. V., Biofizika 30: 894, 1985
4. *Idem.*, In: Biological Effect of Electromagnetic Fields. Problems of their Use and Standardization (in Russian) ONTI NTsI, Pushchino, 1986

Biophysics Vol. 33, No. 2, pp. 377-382, 1988
Printed in Poland

0006-3509/88 510.00+.00
© 1989 Pergamon Press plc

DISTRIBUTION OF THE HEAVY CARBON ISOTOPE (^{13}C) IN BIOLOGICAL SYSTEMS*

YA. M. VARSHAVSKII

Institute of Molecular Biology, U.S.S.R. Academy of Sciences, Moscow

(Received 8 July 1986)

The question of the reasons for the fractionation of the ^{13}C carbon isotope in biological systems is considered. Analysis of the existing experimental data and also theoretical considerations indicate that the differences observed in the isotope composition of the carbon of biomo-

* Biofizika 33: No. 2, 351-355, 1988.

**AUDITORY EFFECTS OF PULSED u.h.f. ELECTROMAGNETIC FIELDS.
ANALYTICAL REVIEW**

V. V. SHOROKHOV and R. E. TIGRANYAN

Institute of Biological Physics, Pushchino (Moscow Region)

(Received 20 May 1988)

STUDY of the auditory effects of u.h.f. pulsed electromagnetic fields (radiosound) is a special very narrow field of electromagnetobiology. Radiosound is of interest as factually the only objectively recorded and steadily repeatable effect of an electromagnetic field (e.m.f.). Therefore, study of it is desirable at least for the sake of elucidating the mechanisms of biological action of the e.m.f. in general, although the phenomenon is of interest in its own right and as a possible public health criterion. The advent of subjective auditory sensations is not a specific reaction of the body but the result of the transformation of electromagnetic to mechanical energy in the tissues of the head. Most investigators agree on this although a single established view of the specific mechanism of the formation of the auditory image has still not taken shape. The review includes over 100 publications known to the authors starting from the very first in 1956; they are grouped into four sections within which chronological order is observed: 1) psychophysical experiments on humans; 2) behavioural reactions of animals; 3) electrophysiological and other phenomenological investigations; and 4) model investigations and possible mechanisms. This is the first time such a review has featured in the Soviet literature.

Paper deposited in full in VINITI as No. 7777-V88.

Dep. 1 November 1988.

MICROSLIT u.h.f. EMITTER FOR BIOLOGICAL OBJECTS

S. V. KOLTUN and R. E. TIGRANYAN

Institute of Biological Physics, U.S.S.R. Academy of Sciences, Pushchino (Moscow Region)

(Received 25 December 1987)

A MICROSLIT u.h.f. emitter has been designed for investigating the functional state of biological objects with a volume to 50 μ l on exposure to u.h.f. e.m.i. with synchronous visual observation with an optical microscope. The structure of the field of the emitter and the main characteristics of the exposure of the object to e.m.i. are considered. The constructive dimensions of the emitter and the dielectric properties of the support are determined by the frequency of the carrier vibration, the wave impedance of the conducting cable and the characteristics of the object studied. The possibility of linking the emitter to the MBI-15 and MBI-3 microscopes is demonstrated. An effective apparatus of a microemitter is produced, the main energy characteristics recorded on irradiation of the model of the biological object and the safety zone for the investigator defined.

The emitter was tried out on microorganisms of the Tetrahymena species (*Tetrahymena pyriformis*) in continuous and pulsed regimes at the carrier frequency of 915 MHz.

Paper deposited in full in VINITI as No. 7772-V88.

Dep. 1 November 1988.

Biophysics, Vol. 34, No. 1, 1989.

ductivity of the con
against a background
persisting for tens of

NT DIPOLE

aces, Vilnius

, shift of the dipole

HE THEORY
EMENTS

distinct sets and the
ements, for exam-
a of the procedure
ncepts "not less",
possible to deter-
epts as "minimal
line with the nu-
wider application
nditions of an in-

572

Annotations of papers deposited in VINITI

to microwave irradiation is explained by the difference in their properties correlating with cell size. Fall in excitability of the high threshold motoneurons results from change in the conductivity of their membrane on exposure to microwave heating. Rise in excitability of the low-threshold motoneurons is apparently linked with activation of the presynaptic excitatory inputs under the influence of microwaves.

Paper deposited in full in VINITI as No. 1442-V89.
Dep. 2 March 1989.

SPECTRAL ANALYSIS OF A SPHERICAL MODEL OF RADIOSOUND

R. E. TIGRANYAN and V. V. SHOROKHOV

Institute of Biological Physics,
U.S.S.R. Academy of Sciences, Pushchino (Moscow Region)

(Received 8 September 1988)

A SPECTRAL analysis has been made of the mechanical oscillations excited in spherical liquid models of radiosound by u.h.f. pulses. It is shown that the fundamental resonance frequency is determined by the relation $c/2a$ where c is the velocity of sound in a liquid and a is the radius of the sphere. The presence of an aperture in the sphere leads to the appearance of frequency components corresponding to a Helmholtz resonator and a four-wave resonator. It is assumed that these components must be absent in the prototype. It is concluded that the low quality factor spherical model satisfactorily reproduces certain essential features of the effect of radiosound.

Paper deposited in full in VINITI as No. 1444-V89.
Dep. 2 March 1989.

*Biophysics, Vol. 34, No. 3, 1989,
pp. 572 (p. 528 in the Russian
original).*

E. L. ANDRONIK
YU. P. KOZLOV,

G. N. BYERESTO'
V. V. L

B. S. BALMUKHANOV,
and K. YE. BULEGE
N. S. SHELUD'KO, I
YU. K. YUDIN

K. M. L'VOV, A. V.
G. S. KALICHAVA, N
G. G. ZIANGIROVA
V. R. GALOYAN
S. K. YEFIMOV, D. G
N. S. SUROVICHEVA
V. V. ANSHELEVICH, F
A. V. LUKASHIN and
M. D. FRANK-KAME
S. R. GUTMAN, A. B
S. V. FOMICHENKO
V. S. GURFINKEL',
YU. S. LEVIK
V. V. REVIN, V. T. N
O. R. KOL'S
M. V. FOK, A. R. Z
G. A. PROKOPENKO

YE. M. TIMANIN

T. V. BURDZHANADZ
M. O. VEZHITADZE
A. P. ZHUKOVSKII and
T. V. BYELOPOL'SKAY
and I. V. SOCHAVA
A. A. MAKAROV, I.
I. A. ADZHUBEI and

Indexed/abstracted in: BIC



I
I
E

REFERENCES

1. MALENKOV, A. G. and KOVALEV, I. Ye., *Biofizika* 31: 162, 1986
2. MATUSHAK, A. A. and SHEPOVAL'NIKOV, N. P., Factors of the Constitution and a Technique for Investigating It in Children and Adolescents (in Russian) Leningrad Otophonic Inst., Leningrad, 1930
3. MALENKOV, A. G. *et al.*, Electrical and Thermophysical Properties of the Human Skin (in Russian) Dep. in VINITI No. 75-85, Moscow
4. IL'IN, B. I. *et al.*, Theoretical and Experimental Studies of the Characteristics of Biological Tissues and Fluids by the Pulse Method (in Russian) Nauka, Moscow, 1981
5. BMDP: Biomedical Computer Programs (Ed. W. Dixon) Univ. California Press, 1979
6. ALEKSANDROV, V. V. and GORSKII, N. D., Algorithms and Programs of the Structural Method of Data Processing (in Russian) p. 62, Nauka, Leningrad, 1983
7. BRAVERMAN, E. M. and MUCHNIK, I. B., Structural Methods of Empirical Data Processing (in Russian) 464 pp., Nauka, Moscow, 1983

Biophysics Vol. 33 No. 4, pp. 752-757, 1988
Printed in Poland

0006-3509/88 \$10.00+.00
© 1989 Maxwell Pergamon Macmillan plc

POSSIBLE MECHANISM OF THE SPECIFIC ACTION OF PULSED U.H.F. FIELDS*

R. E. TIGRANYAN

Institute of Biological Physics, U.S.S.R. Academy of Sciences, Pushchino (Moscow Region)

(Received 29 May 1986, after revision 20 January 1987)

The conditions of excitation of mechanical vibrations by u.h.f. pulses in model liquids have been studied experimentally. The possible role of the different types of excited elastic waves in the formation of specific effects of pulsed u.h.f. fields is reviewed. The biological significance of the excited shear vibrations by u.h.f. pulses is demonstrated. From the results a hypothesis is suggested on the acoustic nature of the mechanism of the specific effects of pulsed u.h.f. fields as a result of generation in biological objects of shear waves by u.h.f. pulses.

THE identification of the mechanism of the biological action of pulsed electromagnetic fields (e.m.f.) of ultrahigh frequency (u.h.f.) is becoming exceptionally important with the wide adoption of pulsed u.h.f. instruments and systems with the most varied functions. Enormous factual material has been gathered and different hypotheses of the mechanism of action proposed.

Many effects called non-thermal (specific) have still not been properly explained. Such effects include disturbances associated with the functioning of excitable structures that are quite inexplicable from the standpoint of the quantity of absorbed energy of

* *Biofizika* 33: No. 4, 698-702, 1988.

e.m.f. pulses [1-5]. The effects described in these communications most clearly demonstrate the presence of an unknown pathway of the transformation of the absorbed electromagnetic u.h.f. energy. Eidi [6] notes that there must be a certain transfer function more informative than the heat released between the cell and the electromagnetic wave

Constitution of
Leningrad Otophono

rties of the Human

Characteristics of
cow, 1981
alifornia Press, 197
Programs of the
1983
of Empirical Data

0006-3509/87
© Maxwell Pergamon Mac

IFIC ACTION

ushchino (Moscow Re
uary 1987)

pulses in model liquids
types of excited elastic
d. The biological signifi
i. From the results a
the specific effects of
hear waves by u.h.f. p

on of pulsed electrom
exceptionally importan
s with the most varie
different hypotheses.

ot been properly exp
ioning of excitable str
antity of absorbed en

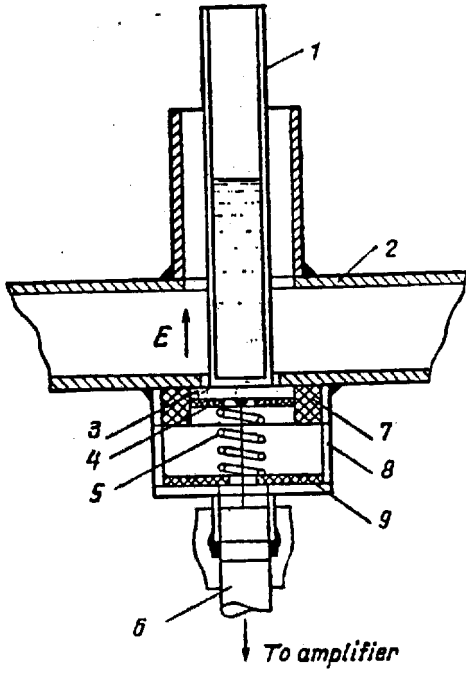

FIG. 1. Schematic representation of the recording node of the mechanical vibrations excited in a liquid: 1-tube containing liquid; 2-rectangular waveguide; 3-piezo crystal; 4-rubber ring; 5-spring; 6-h.f. cable; 7-centring ring; 8-screen; 9-insulating washer.

impinging on the object. More than twenty years ago Kamenskii [7] investigating the action of pulse e.m.f. of ultrahigh frequency on the parameters of conduction of excitation along a nerve concluded that in such a regime of the action of this physical factor summation of the local changes occurs in the nerve preparation. In the present work a hypothesis is advanced on the acoustic nature of the mechanism of the biological action of u.h.f. pulsed e.m.f., i.e. transformation of part of the absorbed electromagnetic energy of the pulse into quite intense mechanical vibrations capable of actively influencing the functional state of the object is taken as a transfer function. It is known [8-11] that on absorption of the energy of a u.h.f. pulse there forms in the medium a thermal pulse the fronts of which changes in the volume of the object leading to the formation in it of mechanical vibrations. The authors of the present paper had his interest aroused in this phenomenon in connexion with the results of comparison of some non-thermal manifestations of the action of pulsed u.h.f. fields and the action of ultrasound on objects of the same type. It turns out that the effects observed are qualitatively adequate [12-18]. This led to the conclusion that during the pulsed action of u.h.f. in biological objects

quite intense mechanical vibrations must be excited capable of actively influencing the functional state of the object. Yet the calculated pressure values of the mechanical vibrations presented in [9, 19] are lower by 4-5 orders (by 8-10 orders in intensity) than those capable of leading to functional or pathological disturbances. To clarify the question we ran a series of experiments on model systems—liquids of organic and inorganic origin and biological objects (the intact brain of the rat, a preparation of the frog tibial nerve and an erythrocyte suspension).

The block diagram includes a u.h.f. generator with a pulse power of 70 W at a carrier frequency of 800 MHz, a rectangular waveguide in the running wave regime, a piezoceramic mechanical vibration detector, a linear amplifier and a S1-54 oscillograph. The objects were irradiated in a tube positioned in the diametral plane of the waveguide. Figure 1 presents the design of the node of fixation of the tube and recording of the mechanical vibrations excited in a liquid. The power flux density in the pulse in the waveguide was 2 W/cm². The height of the liquid column in the tube was varied from 30 to 50 mm. The test of whether these vibrations actually originated from the test liquid was the velocity of sound in a given liquid determined from the relation [20]

$$C = 4lf$$

or

$$C = 4l/n\Delta\tau,$$

where l is the height of the liquid column, cm; f is the frequency of the excited mechanical vibrations, sec⁻¹; $\Delta\tau$ is the time marking of the sweep of the oscillograph, sec; n is the number of markings per period. The liquid column is regarded as a four-wave acoustic resonator. The duration of the pulses in the experiments ranged between 10⁻⁵ and 10⁻³ sec and the repetition frequency was 10-10⁴ Hz. Figure 2 presents an oscillogram of the mechanical vibrations excited in ethanol. With change in the duration of the u.h.f. pulse periodic changes (maxima and minima) in the amplitude of the excited mechanical vibrations were observed. The amplitude of the resulting vibration is determined by the relation

$$A_p = \left[A_1^2 + A_2^2 + 2A_1 A_2 \cos\left(\pi + \frac{2\pi}{T} \tau_1\right) \right]^{1/2},$$

where $A_1 = A_0 e^{-\alpha t}$; $A_2 = A_0 e^{-\alpha(t-\tau_1)}$ are the amplitudes of the dying oscillations excited by the leading and trailing edges of the thermal pulse. Thus the fronts of the thermal pulse may be regarded as two independent sources of mechanical vibrations. Such an approach to the effect observed is also supported by the fact that with change in the duration of the wide u.h.f. pulse (for a duration of the u.h.f. pulse equal to several periods of the excited mechanical vibrations) the amplitude of the mechanical vibrations excited by the leading edge remains unchanged and only that of the mechanical vibrations excited by the trailing edge of the thermal pulse changes. With change in the duration of the u.h.f. pulses not only does the amplitude of the vibrations change but also the character of the wave process—at $\tau_1 = (2n+1)T/2$ the process of generation of the mechanical vibrations is continuous if the repetition frequency of the u.h.f. pulses is close to the resonance fre-



Fig. 2. Oscill

of the object or w
ations following at the
mechanical vibrations). Th
detector equal to 10⁻
an amplitude of the sign
intensity of the excited

the values pre
respectively 0.1 N
the excited mechan
ed. At frequencie
harmonics the am
the system studie
as a contour of ir
vibrations appea
the intensity the q
only longitudinal
shear modul
excited. Consequ
equal to that of
part from the kn
that of the lon
frequency range of
any experiment
an intensity
the intensity of t
attenuation, the
l.s. at a distan
of such wave:

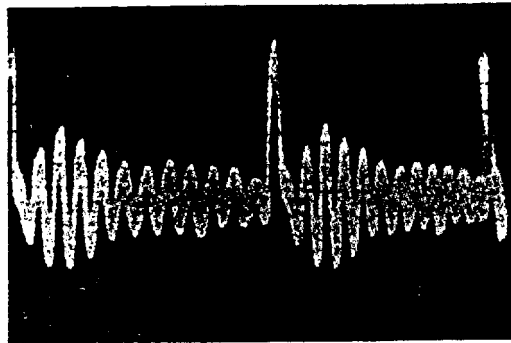

FIG. 2. Oscillogram of mechanical vibrations excited in ethanol.

frequency of the object or waning: at $\tau_1 = nT$ it degenerates into packets of mechanical vibrations following at the frequency of the u.h.f. pulses (T is the period of the excited mechanical vibrations). The pressure amplitude may be evaluated from the sensitivity of the detector equal to 10^{-6} V·dyne $^{-1}$ ·cm 2 . For ethyl alcohol this value was ~ 0.3 N/cm 2 for an amplitude of the signal on the detector of 20–30 mV. From this one may determine the intensity of the excited mechanical vibrations using the known relation

$$I, \text{ W/cm}^2 = p^2/2\rho c.$$

Substituting the values presented we get $I = 3 \times 10^{-4}$ W/cm 2 . For 1 M NaCl solution we obtained respectively 0.1 N/cm 2 and 10^{-5} W/cm 2 . The values of the pressures and intensities of the excited mechanical vibrations obtained correspond to the resonance of the models used. At frequencies of u.h.f. pulses not equal to the resonance frequencies or their subharmonics the amplitude of the electric signal of the detector falls 50–100 fold.

Thus the system studied when exposed to a pulse of electromagnetic energy must be regarded as a contour of impact excitation in which on exposure to an external perturbation free vibrations appear with a frequency close to that of resonance i.e. in evaluating pressure and intensity the quality factor of the system must be heeded. In pure liquids as is known only longitudinal mechanical vibrations are excited. In heterogeneous systems, for which the shear modulus $G \neq 0$ on excitation of the longitudinal waves, shear waves are also excited. Consequently, in a real biological object a shear component with a frequency equal to that of the longitudinal wave will also be present.

If we start from the known findings that the velocity of the shear wave is less by 2–3 orders than that of the longitudinal wave and attenuation is 10^5 times greater [21] then for the frequency range of the excitable mechanical vibrations $\sim 10^4$ Hz (which is observed in many experiments) the intensity of the shear vibrations may be evaluated as follows. For an intensity of the longitudinal waves $\sim 10^{-6}$ W/cm 2 in the absence of resonance the intensity of the shear vibrations is 1 per cent, i.e. 10^{-8} W/cm 2 . In view of the heavy attenuation, the energy of the shear waves is expended on the run of 2–3 wavelengths, i.e. at a distance ~ 300 μ m. If the heterogeneities of the object are regarded as point sources of such waves then in a sphere of 3×10^{-2} cm radius surface area $S = 10^{-2}$

cm² and volume $V = 10^{-4}$ cm³, the density of the energy will be 10^{-2} W/cm³. It may be assumed that the maximum action of the shear waves will occur at the boundary of the lipid membranes in view of the considerable difference in the dielectric constants of the membrane and ambient medium leading to increase in the local energy of the u.h.f. e.m.f. by three orders. In this case the energy density of the shear waves will reach 10

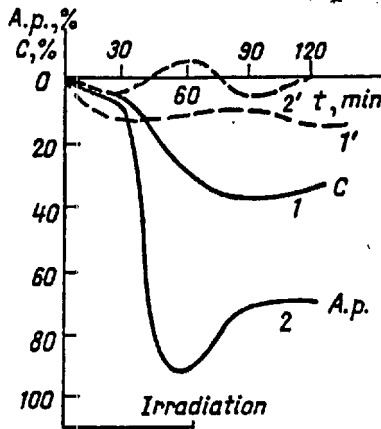

FIG. 3

FIG. 3. Relative changes in the speed of conduction of the wave of excitation (1) and the amplitude of the action potential (a.p.) (2) of the nerve preparation on synchronization of u.h.f. irradiation with the latent period. 1' and 2' - Results of control measurements with change in the speed of conduction of the wave of excitation and amplitude of the action potential.

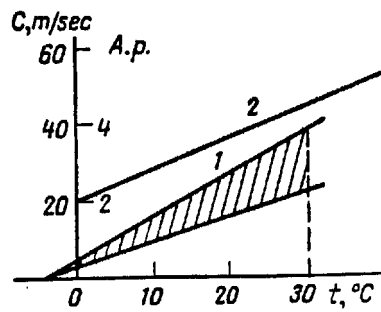

FIG. 4

FIG. 4. Change in the speed of conduction of the wave of excitation (1) and the amplitude of the action potential (2) of the nerve preparation on thermal heating.

W/cm³. Thus, even in the case of non-resonance excitation of the mechanical vibrations the energy density of the shear waves is biologically significant and far exceeds the threshold values.

Comparison of the results on the non-thermal effects of u.h.f. pulsed e.m.f. on excitable structures with data on the effects of ultrasound showed the single direction of the effect recorded. Thus, on exposure of the frog nerve preparation to u.h.f. pulses lasting 3-5 msec with a repetition frequency of 17-23 Hz the speed of conduction of the excitation wave and the amplitude of the action potential (a.p.) decrease (Fig. 3) on total heating of the preparation by not more than 1 K, the shifts of the parameters studied being observed on synchronization of the u.h.f. pulse with a latent period. With a shift of the u.h.f. pulse in time relative to the latent period the effects disappear - the values of the recorded parameters concur with those for the control objects [22].

Thus, for equality of the u.h.f. energy supplied in the two case the effect is manifest only on synchronization of the u.h.f. pulse with the active state of the preparation. A qualitatively similar picture is seen for preparations of the isolated frog heart and innervated muscle [2, 3]. Heating these preparations ought to lead to the known opposite results [23] (Fig. 4). It is significant that for all the preparations indicated increase

the repetition frequency... heating and q... heating.

The values of the amp... vibrations obtained... shear waves allow one... their excitation by

TIGRANYAN, R. E. and... of Electromagnetic... TIGRANYAN, R. E. and... TIGRANYAN, R. E. et al... MENKEL', G. L., Physio... HOLODOV, Yu. A., Ac... DI' U. R., TIER Vol... GUMENSKIL, Yu. I., Bi... ANILOVSKAYA, V. L.,... OSTER, K. R. and FINC... HUBB R. M., J. Appl... TIGRANYAN, L. S., J. Aco... ANOV, K. D. et al... "Fields" (in Rus... J. D. and TUCI... MANN, H. G. an... MANN, H. G. et al... MANN, J. et al., Str... VAZYAN, A. P. and I...

MANN, H. and W... Microwave A... ANDER, R., Biome... A. P. et al... Abstracts UBIC... TIGRANYAN, R. E., Hyp... the u.h.f. Field... BEV, V. N., Di...

in the repetition frequency, i.e. increase in the density of the power flux, led to their appreciable heating and qualitative agreement of the effect with those observed on thermal heating.

The values of the amplitudes of the pressures and intensities of the excited mechanical vibrations obtained and also the evaluation of the volumetric energy density of the shear waves allow one to draw a conclusion on the biological significance of the latter on their excitation by u.h.f. pulses.

REFERENCES

1. TIGRANYAN, R. E. and TYAZHELOV, V. V., Summ. Report All-Union Symp. "Biological Action of Electromagnetic Fields" (in Russian) p. 12, Pushchino, 1982
2. TIGRANYAN, R. E. and PARSADANYAN, A. Sh., *Ibid.* p. 13
3. TIGRANYAN, R. E. *et al.*, *Ibid.* p. 14
4. FRENKEL', G. L., Physiotherapy (in Russian) Vol. 3, Akad. Nauk SSSR, Moscow, 1938
5. KHOLODOV, Yu. A., Advances in Physiological Sciences (in Russian) p. 48, 1982
6. EIDL, U. R., *TIER* Vol. 68, No. 1, January 1980
7. KAMENSKII, Yu. I., *Biofizika* 9: 6, 1964
8. DANILOVSKAYA, V. L., *Prikl. mat. mekh.* 14: 695, 1950; 316, 1950; 16: 341, 1952
9. FOSTER, K. R. and FINCH, *Science* 185: 256, 1974
10. WHITE, R. M., *J. Appl. Phys.* 34: 3559, 1963
11. GOURNAY, L. S., *J. Acoust. Soc. Amer.* 40: 1322, 1966
12. KAZARINOV, K. D. *et al.*, Summ. Reports All-Union Symp. "Biological Action of Electromagnetic Fields" (in Russian) p. 42, Pushchino, 1982
13. FRY, W. J. D. and TUCKER, D., *J. Acoust. Soc. Amer.* 23: 627, 1951
14. HAUSSMANN, H. G. and KEHLER, H., *Optic* 7: 321, 1950
15. HAUSSMANN, H. G. *et al.*, *Hygien.* 134: 565, 1952
16. LEHMANN, J. *et al.*, *Strahlentherapie* 83: 311, 1950
17. SARVAZYAN, A. P. and PASHOVKIN, T. N., Proc. UBIOMED-IV. Vol. 1, Visegrad, Hungary, 1973
18. THEISMANN, H. and WALLHAUSER, K. N., *Naturwissenschaften* 37: 185, 1950
19. JAMES, C., *Microwave Auditory Effects and Application*, 1978
20. ALEXANDER, R., *Biomechanics* (in Russian) Mir, Moscow, 1970
21. SARVAZYAN, A. P. *et al.*, The Role of Shear Properties of Biological Tissues in Ultrasonic Bioeffects. Abstracts UBIOMED VII. p. 54, Eisenach, G.D.R., 1986
22. TIGRANYAN, R. E., Hypothesis on the Acoustic Nature of the Mechanism of the Biological Action of Pulse u.h.f. Fields (in Russian) ONTI NTsBI, Pushchino, 1984
23. VEPRINTSEV, V. N., *Dissert. Cand. Biol. Sci.* (in Russian) Moscow State University, 1960

W/cm
the bound
electric
I energy
waves will



(T) and the
of u.h.f. in
in the spec
potential.
amplitude
g.

mechanic
at and far

sed e.m.f. on
single direct
n to u.h.f.
of conduct
decrease
of the param
a latent
fects disap
trol objects
effect is man
the prepar
l frog heart
he known o
dicated inc

PHYSICAL MODELLING OF THE ACOUSTIC EFFECTS ON EXPOSURE OF BIOLOGICAL SYSTEMS TO U.H.F. FIELDS*

R. E. TIGRANYAN and V. V. SHOROKHOV

Institute of Biological Physics, U.S.S.R. Academy of Sciences, Pushchino (Moscow Region)

(Received 5 March 1984)

A physical model of radiosound is proposed based on the phenomenon of excitation of mechanical vibrations in liquid media on absorption of the energy of u.h.f. pulses. It is shown that a restricted volume of liquid may be regarded as an acoustic resonator with a natural frequency of vibrations. Interference occurs for certain ratios between the period of succession and the duration of the pulses. Oscillograms of the mechanical vibrations recorded are presented. An explanation of the low frequency type of radiosound is offered. It is concluded that the proposed method of investigating the phenomenon of radiosound is correct.

WORK on the effect of radiosound [1-5] has reliably confirmed the appearance of subjective sound sensations on irradiation of the human head with a pulse-modulated u.h.f. field. Nevertheless, there is still no conclusively formed idea of the mechanisms of origin of such sensations. The so-called thermo-elastic hypothesis of the mechanism of radiosound proposed by Lin [6] is the best researched and most consistent. Its essence is to assume that absorption of the energy of the u.h.f. field occurs not uniformly over the whole volume of the brain but is concentrated in its very narrow regions ("hot spots") with their subsequent rapid thermal expansion and detection on the skull bones. Thanks to the presence of bone conductivity the mechanical vibrations reach the organs of hearing where the sound image also forms. But since the author of this hypothesis regards the head as an acoustic resonator he derives a number of consequences consistent with some experiments on radiosound. However, this theory cannot explain a large body of experimental evidence and is in conflict with some of it. Therefore, it may be desirable in order to define certain aspects of this phenomenon to stage experiments on models which would exclude a subjective evaluation by the subject of a particular characteristic of the effect. Foster and Finch observed excitation in a cubic vessel with a side of 300 mm filled with 0.15 M KCl solution of mechanical vibrations on exposure to a pulsed u.h.f. field [7]. This phenomenon was taken as the basis of our experiments.

* Biofizika 30: No. 5, 894-899, 1985.

In choosing the conditions of the experiments the authors sought to follow the parameters and characteristics of the objects known from the literature on the phenomenon of radiosound and also the conditions of earlier experiments.

As objects we used 1 M NaCl solution and ethyl alcohol poured into tubes with an internal diameter 7 mm and height 100 mm. The height of the column of liquid changed within the limits 30–50 mm. The choice of 1 M NaCl solution is explained by the fact that the electrical and acoustic parameters of a given liquid, according to [6], correspond to the parameters of brain tissue. The choice of ethyl alcohol was largely arbitrary though dictated by the wish to show that the advent of mechanical vibrations on irradiation with e.m.f. pulses is not exclusively the property of electrolytes but occurs to an equal degree for non-conducting pure liquids. Irradiation was carried out in a rectangular waveguide with section $31 \times 240 \text{ mm}^2$. To raise the concentration of the field in the zone of the tube on the wide wall of the waveguide was sealed a brass tube of height

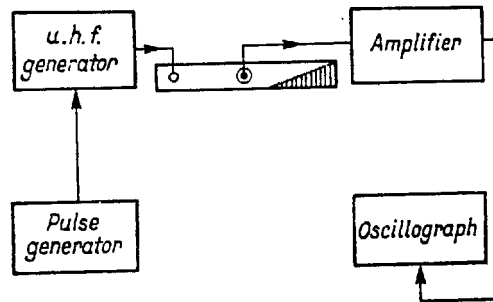

FIG. 1. Circuit diagram of experimental apparatus.

50 mm with an internal diameter 14 mm. The power of the generator in the pulse was 72 W, the repetition frequency of the pulses changed within the limits 10–3000 Hz and the duration of the pulses was $10 \mu\text{sec}$ –1 msec. The mechanical vibrations excited in the liquid were recorded by a bimorphous crystal. The variable electrical signal recorded from the detector was amplified with a UBP1-02 bipotential amplifier and recorded on the screen of a S1-19B oscillograph. As source of u.h.f. e.m.f. we used a modified GS-6 generator, carrier frequency 0.8 GHz. In [6, 7] this phenomenon is considered on exposure to e.m.f. pulses with a carrier frequency of 918–2400 MHz from which it may be concluded that the character of the effect over a wide frequency range is quite general. The apparatus at the disposal of the authors operates at the frequency of 800 MHz which is quite close to the values presented in the literature. Modulation of the u.h.f. vibrations with pulses of square form was carried out with a G5-54 generator. The circuit diagram of the apparatus is indicated in Fig. 1. Figure 2 shows arrangement of the tube with liquid in the waveguide and bimorphous crystal used as detector of the mechanical vibrations. Preliminary investigation established that the amplitude of the vibrations in the tube filled with ethyl alcohol is considerably higher than in the case of NaCl solution. Qualitatively the character of the vibrations for these and other liquids used in the experiments completely matches. Therefore,

Acoustic effect

convenience of description special qualifications figures 3 and 4 give time parameters of excited by both from variation of the e.m.f. excited by the leading edge of the maxima where f is the frequency to the height of the graphs (Figs. 5 and mechanical vibrations on vibrations was determined signal from an e with detector. At the and the mechanic. the oscillograph screen simultaneously on rear:

Arrangement of tube with liquid in the waveguide and bimorphous crystal used as detector of the mechanical vibrations excited by axial e.m.f. pulses.



FIG. 3

Mechanical vibrations excited by axial e.m.f. pulses in ethyl alcohol are considerably higher than in NaCl solution. Mechanical vibrations excited by the pulse

sought to follow
temperature on the
points.

red into tubes
column of liquid

explained by
according to [6], cor

rgely arbitrary
vibrations on irradi

ut occurs to an
out in a rec

on of the field
brass tube

for convenience of description below we give the results obtained for ethyl alcohol if no special qualifications are made.

Figures 3 and 4 give the oscillograms of the mechanical vibrations for the different time parameters of the e.m.f. u.h.f. pulses. For long durations (Fig. 4) the vibrations excited by both fronts of the thermal pulse are clearly visible. The vibration in the duration of the e.m.f. u.h.f. pulse with interference between the mechanical vibrations excited by the leading and trailing edges is observed. The periodicity of the appearance of the maxima (minima) of the amplitude of the mechanical vibrations $\tau = 1/f$ where f is the frequency of the vibrations excited in the liquid, is inversely proportional to the height of the liquid column.

The graphs (Figs. 5 and 6) indicate the dependence of the amplitude of the excited mechanical vibrations on the duration of the acting pulse. The frequency of the mechanical vibrations was determined from the zero beats between these vibrations and the acoustic signal from an electrodynamic emitter. The emitter was 30 cm away from the tube with detector. At the moment of equality of the frequencies of the tonal acoustic signal and the mechanical vibrations excited in the liquid zero beats were observed on the oscillograph screen. In this case the detection itself served as a vibration mixer. Simultaneously on rearrangement of the frequency of the sound generator beats are

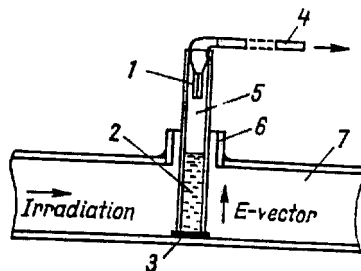

FIG. 2. Arrangement of tube with liquid in waveguide and bimorphous crystal in tube: 1 - detector of mechanical vibrations (bimorphous crystal); 2 - test liquid; 3 - packing (fluoroplast); 4 - coaxial cable; 5 - test tube; 6 - tube; 7 - waveguide.

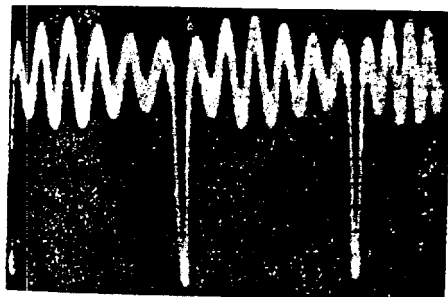

FIG. 3

FIG. 3. Mechanical vibrations excited in ethyl alcohol with a short u.h.f. pulse (duration of pulse less than the half period of mechanical vibrations).

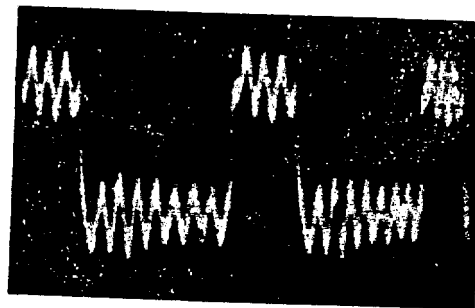

FIG. 4

FIG. 4. Mechanical vibrations excited in ethyl alcohol with a wide u.h.f. pulse (duration of the pulse amounts to several periods of the mechanical vibrations).

tor in the pulse
limits 10-3000

il vibrations can
ble electrical

ential amplifi

f. e.m.f. we

is phenome

of 918-2400

r a wide frequ

rs operates

d in the liter

s carried out

in Fig. 1. Fig

imorphous

gation estab

ol is cons

of the vibr

atches. The

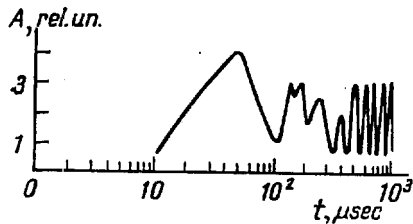

FIG. 5

FIG. 5. Amplitude of mechanical vibrations excited in 1 M NaCl solution as a function of the duration of the u.h.f. pulse.

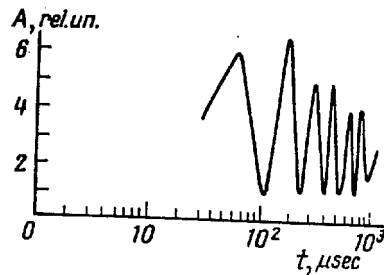

FIG. 6

FIG. 6. Amplitude of mechanical vibrations excited in ethyl alcohol as a function of the duration of the u.h.f. pulse.

observed between the repetition frequency of the e.m.f. u.h.f. pulses and the frequency of the acoustic vibrations from the electrodynamic emitter. The beats are recorded whenever the frequency of the acoustic vibrations is a multiple of the pulsed repetition frequency. As an example, Fig. 6 gives the oscillogram of such beats. The frequency of the acoustic signal is 6×10^3 Hz and the pulse repetition frequency of the e.m.f. u.h.f. is 1.5×10^3 Hz. Zero beats may be observed when these frequencies are equal.

An interesting feature of the experiments is that the vibrations excited in the liquid have an intensity sufficient for their auditory perception from a distance of up to 1 m. The beats of the acoustic signal and vibrations excited in the liquid may also be perceived by hearing. In this case the mixer of mechanical vibrations emitted by the tube with liquid and electrodynamic emitter is the auditory apparatus of the observer. The zero beats on hearing may be recorded in parallel with their visual observation on the oscillograph screen. The values of the frequency of the natural vibrations of the liquid obtained by the method of zero beats recorded by the detector concur with those determined on hearing.

Similarly, parallel recording on the oscillograph screen and on hearing of the maxima and minima of the amplitude of the free vibrations the appearance of which is due to the presence of interference in the vibratory system is possible. Interference appears not only through change in the duration of the pulses (Figs. 5 and 6) at a low frequency of their succession. With increase in the repetition frequency of the pulses and for a short duration of them the excited mechanical vibrations do not have time to wane in the pauses between pulses and starting from a certain value of the repetition frequency interference of the mechanical vibrations is also observed: with agreement of the signs of the initial phases of the vibrations their amplitude grows, in counter-phase the vibrations die away (Fig. 7). At these moments a lower tone corresponding to the pulse repetition frequency is clearly perceived. In the experiment increase in the intensity of the low frequency vibrations perceived on hearing is noted with fall in the repetition frequency of the pulses down to 10 Hz. This is explained by the fact that

Acoustic energy spectrum frequency spectrum of the order of the order

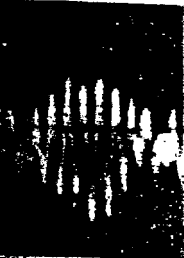

FIG. 7

Beats between

FIG. 8. Quen

We also ran experiments on their irradiation those described in ethyl alcohol has a frequency of the order of the corresponding value of the resonance frequency. The results permit a clarity of the effect of the vibration and visual observation of the liquid on irradiation. The effect of radiation in a test tube is due to the fact that the object on which the model of radiation is applied. In connection with this phenomenon it is not possible to observe resonance characteristics. The temperature in the liquid is about 20 then the calculated value of the amplitude of the pulse power is about 8 W.

in the energy spectrum with fall in the pulse repetition frequency the amplitude of the low frequency spectral component increases [8]. The tone corresponding to the free vibrations of the system is perceived on hearing starting from a pulse repetition frequency of the order 250 Hz.

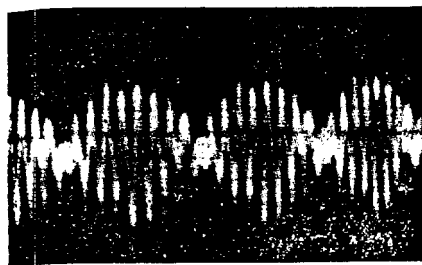

FIG. 7

FIG. 7. Beats between pulse repetition frequency and frequency of acoustic signal, a multiple of the pulse repetition frequency.

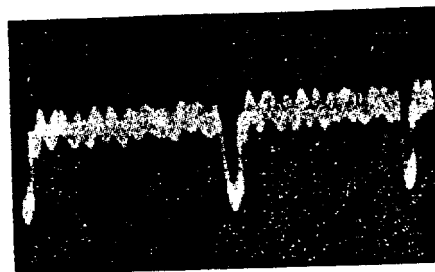

FIG. 8

FIG. 8. Quenching of excited mechanical vibrations as a result of interference.

We also ran experiments on the character of the mechanical vibrations in liquid-filled beads on their irradiation with pulsed e.m.f. u.h.f. All the other conditions corresponded to those described earlier. A bead of diameter 20 mm with a tube 9 cm long filled with ethyl alcohol has a resonance frequency of about 9 kHz and filled with 1 M NaCl solution of the order 11 kHz. For a bead of diameter 30 mm with a tube 8 cm long the corresponding values are 6.4 and 8 kHz. A sealed 30 mm bead containing alcohol has a resonance frequency of 7.8 kHz.

The results permit some assumptions on the possible mechanism of radiosound. The clarity of the effect investigated in the experiments, the possibility of direct auditory perception and visual observation on the oscillograph screen of the vibrations excited in the liquid on irradiation of the tube with pulsed e.m.f. u.h.f. support the assumption that the effect of radiosound is due to the same processes as generation of sound vibrations in a test tube containing liquid; namely: transformation of the diminishing e.m.f. energy into the mechanical energy of the absorbing substance. From this point of view the object on which the investigations were carried out may be regarded as a physical model of radiosound and the results of the model experiments be interpreted in relation to this phenomenon. However, it should be noted that within the model described it is not possible to explain the effect of high frequency radiosound [9, 10] of a non-resonance character. But, if one starts from the fact that the measured rate of rise in temperature in the tube was $0.1^{\circ}\text{C sec}^{-1}$ for 1.5 cm^3 1 M NaCl solution for a pulse porosity 20 then the UPM for this object has a value of the order 8.4 kW/kg in the pulse. The calculations show that for such a UPM the power absorbed by the tube must be about 8 W in the pulse. Accordingly, to excite the mechanical vibrations of the same amplitude in a volume of $2.5 \times 10^3\text{ cm}^3$ (the volume of the head of the human adult) a pulse power of the generator of not less than 13 kW is necessary. Naturally,

in our experimental conditions such vibrations could not be recorded owing to the considerably lower power of the generator. Nevertheless, it is obvious that if resonance were detected in this system the quantitative results of the experiments would entitle us to give a reliable interpretation of them in relation to the effect of radiosound.

It is also interesting to compare the experimental results obtained with those presented in Lin's work [6]. The author considering the characteristics of the effect of radiosound proposed for its explanation a mathematical model of the action of a single e.m.f. pulse on a liquid-filled sphere. Lin moved away from the real situation automatically replacing the linear spectrum occurring on exposure to a sequence of pulses of a definite repetition frequency by a continuous one. The dependences obtained by Lin of the sound pressure on the duration of the pulse are not commented on. If one starts from the fact that the sound pressure must change in tandem with the frequency of the elastic mechanical vibrations then from the calculated graphs presented in Lin's work, it follows that a sphere of radius 3 cm must vibrate with a frequency of about 150 kHz and one with a radius of 7 cm with a frequency of about 66 kHz. However, here the dependence of the resonance frequency on the radius of the sphere is presented and the commentary gives the resonance frequencies for radii of 3 and 7-10 cm and 25 of 7.3-10.4 kHz. This contradiction is not explained and it remains only to postulate the causes of its appearance.

On the other hand, our experimental findings show that as a result of interference the maxima (minima) following each other allow one to determine the resonance frequencies for a liquid column as a four-wave resonator.

Thus, the following conclusions may be drawn from the work undertaken.

1) A tube filled with liquid may be regarded as a physical model for investigating the phenomenon of radiosound. This follows from the obvious assumption that radiosound and excitation of sound vibrations in a liquid are based on the same mechanism - transformation of the diminishing e.m.f. energy into mechanical vibrations of the absorbing substance.

2) The so-called second type of radiosound [9, 10], namely perception of a low frequency tone in the absence of resonance vibrations is explained by the presence of mechanical vibrations corresponding to the pulse repetition frequency at the moments when the high frequency components corresponding to the natural frequency are suppressed as a result of the run-on of the phase.

3) On detection of the resonance properties of the head which can be done only on a model since the calculated powers necessary for the advent of vibrations in such a system well exceed the safety norms, the quantitative results of the model experiments may be applied quite correctly to the description of the effect of radiosound.

REFERENCES

1. FREY, A. H., *Aerosp. Med.* 32: 1140, 1961
2. *Idem*, *J. Appl. Physiol.* 17: 689, 1962
3. *Idem*, *J. Med. Electron* 2: 28, 1963
4. *Idem*, *J. Appl. Physiol.* 23: 984, 1967

Idem, *IEEE Trans*
 LIN, J. G., *Micro*
 POSTER, K. R. a
 KHARKEVICH,
 KHIZNYAK, E.
 KHIZNYAK, E.
 101, Paris, 198

Vol. 30 No. 5.
 in Poland

SPECTS OF

Institute of Prob

transforming t
 moments of
 movements for
 bit constan
 Therefore,
 depends signifi

ing of pr
 for wh
 the traje
 is chara
 rises and
 energetic ar
 energet
 ularly du
 displacer
 the trajec
 during wa
 touched el

ofizika

5. *Idem*, IEEE Trans. MTT 19: 153, 1971
6. LIN, J. G., Microwave Auditory Effects and Applications, Springfield, Illinois, 1977
7. FOSTER, K. R. and FINCH, E. D., Science 185: 256, 1974
8. KHARKEVICH, A. A., Spectra and Analysis (in Russian) Fizmatgiz, Moscow, 1962
9. KHIZNYAK, E. P. *et al.*, Activ. nerv. sup. 21: 247, 1979
10. KHIZNYAK, E. P. *et al.*, Proc. URSI-CNFRS Symp. Electromagnetic Waves and Biology, p. 101, Paris, 1980

Biophysics Vol. 30 No. 5, pp. 981-987, 1985
Printed in Poland

0006-3509/85 \$10.00 + .00
Pergamon Journals Ltd.

ASPECTS OF THE REGULATION OF HUMAN LOCOMOTOR MOVEMENTS*

V. A. BOGDANOV

Institute of Problems of Information Transmission, U.S.S.R. Academy of Sciences, Moscow

(Received 18 September 1984)

Transforming the experimental kinematic data to normal coordinates and calculating the moments of the muscular forces during walking the author found that the locomotor movements for each degree of freedom of the leg are regulated almost discretely so that the two bit constant control parameters are switched a small number of times in the cycle of the step. Therefore, the musculature acts like switchable elastic links and the energy expenditure depends significantly less on the trajectories of movement than on the kinematic conditions at fixed moments of switching.

Posing of problem. Earlier, it was shown [1] that muscular actions are theoretically possible for which the energy expenditure depends on the goal of the movement but not on the trajectories along which the goal is reached. The control of such muscular actions is characterized by parameters instantly changed when the next goal of movement arises and constant until the goal is reached. This principle of control was called iso-energetic and the changes in the parameters termed switching. It was found [2] that iso-energetic control is used in rhythmic movements of the arm in the elbow joint.

Similarly during locomotions of man and animals the goal of movement consisting in the displacement of the body to the necessary point in space appears more important than the trajectories of movement. Statistical analysis of the published data showed that during walking by man the muscular actions in the joints resemble the actions of switched elastic links [3]. Let us see whether the intermediate goals of movement

* Biofizika 30: No. 5, 900-904, 1985.

TAB

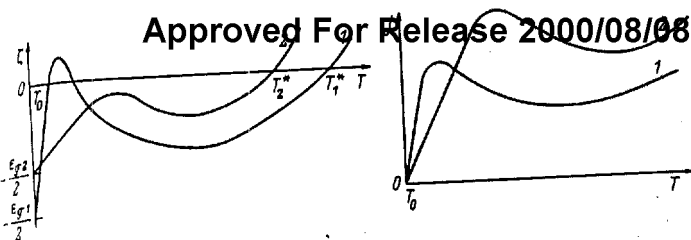

FIG. 1. Dependence of the position of the Fermi quasilevel ζ (a) and of the injection current density j (b) on the temperature of the electron gas for various gap widths ($\epsilon_{g1} > \epsilon_{g2}$).

we would have $j_{th} \sim 10-100 \text{ A/cm}^2$ - at least an order of magnitude lower than the experimental threshold current density.¹ In these lasers, therefore, Auger recombination leads only to a heating of the electrons.

The current in the active region of injection lasers results primarily from carrier diffusion,¹ so that we may ignore the Joule heating in Eq. (3) in this case. Furthermore, the term r_A in Eq. (1), which corresponds to Auger recombination, is assumed to be small in comparison with the rate of radiative recombination, r_I . The dependence of the threshold current on the lattice temperature can now be determined from the onset of degeneracy of the electron gas, which can be found by solving system (1)-(3), with T_0 fixed, and with T treated as a parameter. The expression for the rate of Auger recombination in this case is

$$r_A \approx \beta(T) e^{-E_i/2T} n [n^2 - n_i^2(T)], \quad (5)$$

where $E_i = \frac{m_{\perp}}{m_{\parallel}} \epsilon_g$ (m_{\perp} and m_{\parallel} are the transverse and longitudinal electron masses), $n_i(T)$ is the equilibrium intrinsic electron density, and $\beta(T)$ is a smooth function of the temperature T and is given in Ref. 4. We evidently have $r_I(T) \approx \gamma(T)n^2$, where $\gamma(T)$ is also a smooth function of T (Ref. 1). Figure 1 shows some typical curves of the position of the Fermi quasilevel ζ and of j as functions of the temperature T for various values of ϵ_g , plotted under the assumption $T_0 \ll E_i$.

The maxima in these curves result from the activation nature of the Auger recombination. If the electron gas does not become degenerate when $\zeta(T)$ reaches a maximum (as on curve 2), the degeneracy sets in at a temperature $T^* \sim E_i$ which is essentially independent of the lattice temperature T_0 . This case corresponds to an S-shaped dependence of T on the pump current j . Using the expression from Ref. 4 for $\beta(T)$, and using the estimate $\nu_E \sim 10^{+7} \text{ s}^{-1}$, one can show that for $T_0 > 10 \text{ K}$ curve 2 corresponds to semiconductors with gap widths $\epsilon_g < 0.1 \text{ eV}$.

In summary, for injection lasers made from semiconductors of this type the threshold pump current becomes a function of the lattice temperature only at $T_0 \gg E_i \sim 0.1 \epsilon_g$. This conclusion is in good agreement with the experimental data.

¹T. X. Hoal, K. H. Herrmann, and D. Genzow, Phys. Status Solidi A 64, 239 (1981).
²G. Nimtz, Phys. Rept. 63, 265 (1980).
³R. W. Keyes, Proc. IEEE 63, 740 (1975).
⁴P. R. Emtage, J. Appl. Phys. 47, 2565 (1976).

Translated by Dave Parsons

Informational nature of the nonthermal and some of the energy effects of electromagnetic waves on a living organism

N. D. Devyatkov and M. B. Golant

(Submitted July 10, 1981; resubmitted November 26, 1981)

Pis'ma Zh. Tekh. Fiz. 8, 39-41 (January 12, 1982)

PACS numbers: 87.50.Eg, 87.10. + e

It was noted a long time ago that living organisms may be affected significantly by electromagnetic waves in the radiofrequency range at a very low intensity, below that which would cause any significant heating of tissues.¹ These effects have been labeled "nonthermal" or "specific" effects. There are, however, no clear criteria for judging an effect to be "specific" (the fact that the temperature change is small cannot serve as such a criterion, if only because the wave energy and, hence the temperature can be increased significantly without affecting the results in several cases²). In the absence of clear criteria, there have been difficulties in deciding whether an effect is a specific effect or a thermal effect (or an "energy" effect¹).

in some particular case or other, and there has been some doubt that specific effects should be singled out as a special group. The phrase "specific effect" has frequency been replaced by "information effect" in more recent years, but this change does not eliminate the difficulties, since no clearer criteria for this concept have emerged.

A study of the influence of millimeter-range electromagnetic waves of a nonthermal intensity on living organisms of various complexity levels was published in 1973 (Ref. 2). The organisms studied ranged from microorganisms to mammals. Some general conclusions about these effects were formulated.

1) The effect of the waves on the organism is resonant manner: The results change substantially upon a small deviation from the frequencies at which the waves are most effective.

2) The effect is essentially independent of the intensity of the electromagnetic waves above a certain minimum (threshold) level and below the level at which a significant heating of tissues is observed.

The reasons for the resonant nature of the effect have been discussed by several investigators (see Refs. 2-4, for example), while the second of these facts has not yet been convincingly explained. This second fact is apparently the key to an understanding of the essence of information effects.

We begin our discussion by considering one aspect of the operation of cybernetic devices used in technology. These devices work only in those cases in which the results of their operation are not, over a broad range, affected by changes in the signals generated in the information-processing systems. The minimum signal levels required for operation of a device are usually determined by the requirements for shielding the device from noise and stray pickup. The maximum permissible signal levels are determined by the possibility of damage or of changes in the operating conditions of the device. Let us examine the situation in somewhat more detail.

The input of the cybernetic device receives a set of signals which represent the arriving information as a set of quantities and operations on these quantities. Emerging from the output of the device is a set of signals which represent information obtained as a result of the processing of the data which arrived at the input. The information which arrives at the input must be unambiguously related to the information taken from the output.

As the device processes information received at its input, however, auxiliary signals are generated in it. The level of these signals cannot be independent of the working state of the elements making up the device, and this working state unavoidably changes over time. Consequently, cybernetic devices which ensure an unambiguous correspondence between the information received at the input and the information taken from the output can operate reliably only if this relationship does not depend, within the specified limitations, on the level of the auxiliary signals generated in the information-processing system.

It is natural to suggest that in a living organism the level of the signals generated by the information-processing systems does not, over a broad range, influence the relationship between the received information and its effect on the corresponding organ. In terms of the information effect on the organism, electromagnetic waves which are incident from outside the organism may be similar to signals generated by the information-processing systems of the organism itself. The discussion of threshold and maximum signals is similar to that above. There is another

piece of evidence indicating that "specific" effects are of an informational nature: If an animal is subjected to a "specific" stimulus, the region irradiated by the electromagnetic waves does not necessarily have to coincide with the affected region. The necessary "command" can be transferred through one of the information-transfer channels in the organism.

An important point is that the energy effects of the electromagnetic waves may simultaneously be information effects on the organism. The interrelationship between the information effects and energy effects of a signal can be explained with the help of an example. The meaning of some text (information) does not depend on the intensity at which it is illuminated. On the other hand, the illumination intensity determines the energy effect of the light on the eye.

Accordingly, a distinctive feature which determines the informational nature of an effect of electromagnetic waves is not the absence of tissue heating but the essential independence of the effect from the intensity of the electromagnetic waves over a broad range. In many cases (including those discussed in Ref. 2) an information effect on an organism is determined by the frequency (or, more generally, by the spectrum of frequencies) of the waves and is related to the resonant dependence of such effects on the wave frequency which we mentioned earlier.

Since several organs and systems are working simultaneously and in a coordinated manner in a living organism exchange of information between these organs and systems and processing of this information are absolutely necessary. Alterations in its information exchange may strongly affect the working conditions of the organism; in particular, many diseases result from disruptions of information-processing and -transfer systems. In certain cases, therefore, the use of information effects may prove very successful.

1) The more rigorous term "energy effect" should be applied to any effect whose magnitude is decisively influenced by the amount of energy or power.

¹A. S. Presman, *Electromagnetic Fields and Animate Nature* [in Russian], Nauka, Moscow (1968).

²"Scientific Session of the Division of General Physics and Astronomy, Academy of Sciences of the USSR (January 17-18, 1973)," *Usp. Fiz. Nauk* **110**, 452 (1973) [*Sov. Phys. Usp.* **16**, 568 (1974)].

³H. Fröhlich, *Phys. Lett.* **51A**, 21 (1975).

⁴F. Kaiser, *Symposium on the Electromagnetic Waves and Biology*, CESA Center, France, June 30-July 1, 1980.

Translated by Dave Parsons

TAB

Role of coherent waves in pattern recognition and the use of intracellular information

M. B. Golant and P. V. Poruchikov

(Submitted December 15, 1988)

Pis'ma Zh. Tekh. Fiz. 15, 67-70 (August 26, 1989)

It was shown in Refs. 1 and 2 that the coherent acoustoelectric waves which are generated by cells (and whose length is smaller than that of electromagnetic waves by a factor of about a million) may play a role as a high-information-content facility in the acquisition of data about processes involving breakdown of the normal operation of the cells.

The rate at which information is processed and the amount of information which is processed, however, depend to a large extent on the manner in which this information is perceived and processed. From this standpoint, the most effective methods are pattern recognition and processing of information in complex organisms. The perception of a visual pattern is usually cited to illustrate this point. The human eye, for example, has about $250 \cdot 10^6$ receptors, which simultaneously perceive different elements of the object being observed, establishing in the brain a pattern similar to that of this object.³ This circumstance is of exceptional convenience for mental manipulation of the pattern as a unified whole and results in huge savings in both the memory and the processing facilities required for the manipulation. The result of the processing of information is then realized in actions which are carried out at the level of organs (hands, feet, muscles, etc.). The human brain, however, which has only about 10^9 - 10^{10} cells, cannot perform a modeling of the processes which are carried out at the cellular level in an organism, since the number of cells in an organism is 10^{14} - 10^{15} . For this reason, processes at the cellular level may be controlled primarily by systems of the cells themselves. R. Vikhrov's suggestion that any pathology is related to a pathology of a cell remains important even today.

It is natural to ask whether the perception and processing of information about breakdown, which are carried out in cells by means of coherent waves in the extremely-high-frequency range are of a pattern nature. A stress reaction of an organism as a whole (a nonspecific response of an organism to a change in its condition of existence) is, from the standpoint of phases of adaptation to changes, similar to the responses of a cell to unfavorable changes (Ref. 4). It might thus be suggested that there is a similarity in the organization of the control.

The ideas of Refs. 1 and 2 have been developed

further, as described briefly in Ref. 5, among other places. This work has led to the suggestion that the organic changes in a cell which lead to a disruption of the shape of cellular membranes result from the excitation of coherent standing acoustoelectric waves in these membranes. These waves are presumably most intense in regions of a disruption. The frequency of the oscillations is determined by the nature of the disruptions. Theoretical work has shown¹) that the field of these waves, which are partially radiated into the surrounding space and converted into electromagnetic waves, causes the dipoles of protein molecules which are oscillating at frequencies close to the frequencies of the waves excited in the membrane to be attracted toward the membrane. The attractive forces acting on the protein molecules are proportional to $\sin^2 \omega t \cos[(2\pi/\Lambda)\xi]$, where Λ is the length of the acoustoelectric wave, and ξ is the coordinate along the surface of the membrane. These attractive forces are periodic (their period is Λ , rather than $\Lambda/2$, as in standing waves). These forces are weak enough that a flux of protein molecules toward the membrane is formed as a result of a gradual buildup of directed displacements against the background of Brownian motion.

In the immediate vicinity of the surface of the membrane, a force determined by the interaction of the polarization field, which is strong (10^7 V/m), with the constant component of the dipole moment of the protein molecules acts on the dipoles of these molecules. As a result, kinetic energy is transferred from the protein molecules to the membrane (the average transfer is kT). The collisions of the protein molecules may eliminate the distortion of the shape of the membranes.

Protein molecules adhering to the membrane execute oscillations which are sustained by virtue of metabolic energy in the cell. Being synchronized by the oscillations in the membrane, they may transfer this energy to the alternating field of acoustoelectric waves which are excited there, thereby replenishing the energy expended on controlling the moving flux of protein molecules.⁶

There is a clear distinction here between the control process and the energy process of eliminating the deformations. The control process is predominantly the directing of the flux of protein mole-

Approved For Release 2000/08/08 : CIA-RDP96-00789R003100280001-7

cules to the distorted part of the membrane by means of weak alternating components of the field of acoustoelectric waves and the fields of the electromagnetic oscillations into which the acoustoelectric waves convert upon radiation. In the course of the energy process, on the other hand, the protein molecules transfer the average kinetic energy of their thermal motion to the membrane in the region in which it is distorted. The process of eliminating pathological deformations is essentially a "self-healing" of the cells.

From the standpoint of the answer to the question posed above, this process can be interpreted in the following way. The distribution of the amplitude and the frequency of the coherent waves excited in the membrane reflects the nature of the disruptions in the membrane. In other words, it is the pattern of shape disruptions of the membrane, coded in the frequency and distribution of the amplitude of the field, which affects the processes which occur in the interior of the cell (here, the energy processes are also included), leading to the elimination of the disruptions and the maintenance of homeostasis.

It seems to us that this interpretation of the process is of more than theoretical importance. It might also have some substantial practical consequences. Since the frequencies of the oscillations excited in the membrane are determined primarily by the nature of the distortions of the shape of the membrane, identical distortions in different parts of a membrane will lead to the excitation of the same frequencies. The nature of the disruptions of the functioning of a cell (the nature of the "disease"), however, depends on the orientation of the distortion with respect to the positions of the cellular organelles. In other words, the same oscillation frequencies may cooperate to eliminate different disruptions. The richness of the pattern perception of information about intracellular changes and of the pattern control of actions performed on these changes is determined by the frequency-coordinate nature of the perception.

The application of external radiation to a cell is effective to the extent that it corresponds to the coherent intrinsic radiation which is generated by the cells upon corresponding disruptions.

Since the pathology of the overall organism is, as we have already mentioned, related to a cellular pathology, the same frequencies may prove useful in the healing of quite different diseases. Indeed, the first studies in this direction have revealed that the spectrum of the biological action of oscillations of a certain frequency is very wide, and, while a certain spectrum of generated frequencies corresponds to a certain type of disruption, the inverse conclusion cannot be drawn: A certain frequency spectrum of actions (i.e., only one of the coding factors) may correspond to the possibility of healing different disruptions.

¹This work was carried out by M. B. Galant and N. A. Savost'yanov.

¹N. D. Deyatkov and M. B. Golant, *Pis'ma Zh. Tekh. Fiz.* **8**, 39 (1982) [*Sov. Tech. Phys. Lett.* **8**, 17 (1982)].

²N. D. Deyatkov and M. B. Golant, *Pis'ma Zh. Tekh. Fiz.* **12**, 288 (1986) [*Sov. Tech. Phys. Lett.* **12**, 118 (1986)].

³L. A. Cooper and R. N. Shepard, *Sci. Am.* **251**, No. 12, 106 (Dec. 1984).

⁴A. D. Braun and T. P. Mozhenok, *Nonspecific Adaptive Syndrome* [in Russian], Nauka, Leningrad (1987).

⁵M. B. Golant, in: *Problems of Physical Electronics* [in Russian], M. I. Kalinin Polytechnical Institute and A. F. Ioffe Physico-technical Institute, Leningrad (1988).

⁶M. B. Golant and T. B. Rebrova, *Radioelektronika* No. 10, 10 (1986).

Translated by D. P.

Defect formation in thin films bombarded with high-energy protons

S. G. Lebedev

Institute of Nuclear Research, Academy of Sciences of the USSR

(Submitted February 9, 1989; resubmitted June 28, 1989)

Pis'ma Zh. Tekh. Fiz. **15**, 70-72 (August 26, 1989)

The radiation-induced structural defects in solids bombarded by high-energy protons, of energy $T > 100$ MeV, are determined by both elastic (electromagnetic and nuclear) and inelastic interactions of the primary protons with the target atoms. The recoil nuclei which acquire energy as a result of nuclear interactions of protons create atom-atom collision cascades which are greater in extent than the cascades which start at the atoms that are the first ejected from their positions in Coulomb interactions, and these recoil nuclei are primarily responsible for the formation of defects.¹

A fraction $\eta(T)$ of the energy of a recoil nucleus is expended on electronic excitation, while another fraction $\nu(T)$ is expended on the formation of radiation-induced point defects in elastic interactions of the recoil nucleus with target atoms. The NRT standard² is widely used to calculate the function $\nu(T)$. To evaluate the rate at which point defects are generated by radiation, we need to know the effective cross section for defect formation, σ_d , and the number of defects, $n_d = \nu(T)/(2E_d)$, produced by the first-ejected atoms in the cascade of subsequent atom-atom collisions (E_d is the minimum energy suf-

TAB

Biophysics Vol. 28, No. 5, pp. 952-954, 1983
Printed in Poland

0006-3509/83 \$10.00+.00
© 1984 Pergamon Press Ltd.

DISCUSSION

ROLE OF SYNCHRONIZATION IN THE IMPACT OF WEAK ELECTROMAGNETIC SIGNALS OF THE MILLIMETRE WAVE RANGE ON LIVING ORGANISMS*

N. D. DEVYATKOV, M. B. GOLANT and A. S. TAGER

(Received 28 September 1982)

The possible mechanism of the action of weak electromagnetic radiation on living organisms is discussed based on the assumption of electromechanical autofluotuations of cell substructures (for example, portions of the membranes) as the natural state of living cells. It has been established that synchronization of these autofluotuations by external electromagnetic radiation leads to the appearance of internal information signals acting on the regulatory systems of the body. This hypothesis helps to explain the known experimental data.

It is known that the electromagnetic radiation of the millimetre wave range e.m.r. of very low (non-thermal, i.e. not appreciably heating the tissues) power may exert a fundamental action on various living organisms from viruses and bacteria through to mammals [1]. The spectrum of the e.m.r. induced biological effects is also extremely wide — from change in enzymatic activity, growth rate and death of microorganisms through to protection of bone marrow haematopoiesis against the action of ionizing radiations and chemical preparations [1]. Many years of experimental research have established the main patterns of the action of e.m.r.: its "resonance" character (the biological effect is observed in narrow—from tenths of a per cent to percentage units—frequency intervals and starting from a certain threshold value practically does not depend on the intensity of the e.m.r.); the high reproducibility of the resonance frequencies in repeat experiments; 'memorization' by the organism of the action of the e.m.r. over a more or less long period if irradiation lasts a sufficiently long time (usually not less than 1 hr); the non-critical nature of the observed biological effect to the irradiated portion of the animal body, etc. [2].

The most general conclusion arising from analysis of the patterns identified is that the action of the e.m.r. on live organisms is not of an energetic but information character [2, 3], the primary effect of the e.m.r. being realized at cell level and associated with biostructures common to different organisms. Such structures may be, in particular, elements of cell membranes† with a considerable dipole electric moment, molecules of protein enzymes, etc., for which, as shown by evaluations the frequencies of the natural mechanical vibrations lie (depending on the speed of sound) in the interval $(0.5-5) \times 10^{10}$ Hz.

Below is described the most probable, in our view, mechanism of action of e.m.r. on fluctuations in cell structures and the appearance of information signals in the body.‡

* Biofizika 28: No. 5, 895-896, 1983.

† Such an assumption has been advanced by many investigators. S. Ye. Bresler was the first to point out this possibility to the authors.

‡ The problem of transformation of information signals into control signals is not considered here.

Role of synchron

The initial assumption is that a certain part of the oscillatory autofluotuations sustained are affected not with excitation characteristics of auto-fluctuation spectrum. We shall assume cell membranes.* Sets of portions of the membranes o

A simplest model of such generators (oscillators) weak in each of which the auto-synchronization of the

of the links between the synchronous regimes, if they exist. Therefore, it may be expected

of different oscillators, including only so that the mean value

close to zero is the macroscopic

of such fluctuations — they form an information system of the body

in this situation, however, magnetic field. If the frequency

of the autofluotuations of the harmonics and subharmonics

(synchronization) by the external signal is determined by the main

group and depends little on the synchronization is accompanied

by the phases of these oscillations.

Basic oscillations of the effects (for example, in the medium) and serve

the above mentioned effects, which the actions of

structurally different sets of frequencies

effects.

A characteristic feature of the external signal received at the level in the system

of a given group. Increase in the character of the synchronous

of the oscillations of the elements of the cell structure

The fixation of new effects and the mentioned effect

of the auto-fluctuations of the external harmonics

mechanism of excitation

Role of synchronization in impact of weak electromagnetic signals

953

The initial assumption is that in the living organism and in the absence of external action all or a certain part of the oscillatory degrees of freedom of certain biostructures is in the regime of coherent autofluctuations sustained by the energy of metabolism [4]. The effect of an external e.m.r. is connected not with excitation of the fluctuations in biostructures but with change in particular characteristics of auto-fluctuations already existing in the living organism, in particular, with change in their spectrum. We shall assume that the auto-fluctuations appear in portions of the lipid skeletons of the cell membranes.* Sets of normal fluctuations with an almost identical spectrum correspond to portions of the membranes of the given cell similar in structure or in identical cells adjacent to it.

The simplest model of such a structure may be the totality of a large number of elementary autogenerators (oscillators) weakly joined together. The whole set may be broken down into several groups in each of which the autogenerators are almost identical. Within each group, in principle, mutual synchronization of the oscillators is possible although because of rapid weakening with distance of the links between the elements of structure and a certain difference in the frequencies, asynchronous regimes, if they exist, are localized in small portions between which synchronization is absent. Therefore, it may be expected that in the usual conditions the phases of the auto-fluctuations of different oscillators, including those of a given group with close frequencies, are distributed randomly so that the mean value of the sum of the phases of all autofluctuations is close to zero. Also close to zero is the macroscopic (mean over a large number of portions of the same type) effect of such fluctuations—they exert the minimal action on other cell structures and do not burden the information system of the body.

The situation, however, may fundamentally change on exposure of the cells to an external electromagnetic field. If the frequency of the external agent sufficiently closely approaches the frequency of the autofluctuations of one of the above mentioned groups of almost identical oscillators (or to the harmonics and subharmonics of this frequency) the auto-fluctuations are 'captured' (synchronization) by the external signal. The centre of the synchronization band (resonance frequency) is determined by the mean weighted value of the partial frequencies of the oscillators of a given group and depends little on the deviations of the partial frequencies of the individual oscillators. Synchronization is accompanied by phasing of the oscillations of all the elementary autogenerators—the phases of these oscillations concur with the phase of the external signal in a given portion of the structure.

Such cophasic oscillations of identical portions of the cell membranes may produce different macroscopic effects (for example, excitation of electromagnetic or electro-acoustic waves in the surrounding medium) and serve as an information signal for the regulatory systems of the body. For any of the above mentioned groups of autogenerators there may exist several resonance frequencies at which the actions of the external signal will lead to the same or similar biological effect. Since other structurally different portions of the membranes have their own spectrum of auto-fluctuations other sets of frequencies may also be observed at which the external signal produces different biological effects.

A characteristic feature of the phenomenon of synchronization of auto-fluctuations is the low power of the external signal required for synchronization the threshold value of which depends on the noise level in the system and the scatter of the partial frequencies of the individual autogenerators of a given group. Increase in the power of the external signal above threshold does not change the character of the synchronized oscillations.

The phasing of the oscillations on synchronization may be accompanied by conformational rearrangements of the cell structures since the auto-fluctuations influence the stability of mechanical systems [6]. The fixation of new conformations involving metabolic processes in the cells may explain the above mentioned effect of "memorization" by the organism of prolonged action of e.m.r. The phasing of the auto-fluctuations of cell structures may apparently appear not only under the influence of the external harmonic signal but also as a result of mutual synchronization of the oscillations.

* The mechanism of excitation of auto-fluctuations in membranes is discussed in [5].

tors due to their rearrangement with change in the conditions of existence or internal mobilization of the organism.

It is natural to assume that the auto-fluctuations of portions of the membranes in the cells of a living organism are not only a means of information transmission, there role is much wider. In particular, auto-fluctuations, even not synchronous, must exert a fundamental influence on ionic and molecular transport across the membranes. The fluctuating portion of the membranes acts as a pump the mechanism of action of which is based on the vibration displacement of particles (on average, in a certain direction) under the influence of periodic (on average, not directed) forces [7]. The synchronization of the auto-fluctuations of different portions of the cell membranes may fundamentally influence the processes of membrane transport and hence the properties and vital activity of the cells.

The assumption that the biological action of e.m.r. on live organisms is connected with the external synchronization of the natural autofluctuations of cell structures also agrees with other patterns of this phenomenon not mentioned here.

REFERENCES

1. DEVYATKOV, N. D. *et al.*, Radiobiologiya 21: 163, 1981
2. DEVYATKOV, N. D. *et al.*, Electronic Techniques. Ser. UHF Electronics (in Russian) 9, (333) 43, 1981
3. DEVYATKOV, N. D. and GOLANT, M. B., Letters (in Russian) Zh. tekhn. fiz. 1, 39, 1982
4. FRÖLICH, H., Advances Electr. Electron. Phys. 55: 147, 1980
5. LIBERMAN, Ye. A. and EIDUS, V. L., Biofizika 26: 1109, 1981
6. CHALOVSKII, V. N., Dokl. Akad. Nauk SSSR 110: 345, 1956
7. BLEKHMAN, I. I. and DZHANELIDZE, G. Yu., Vibration Displacements (in Russian) p. 412 Nauka, Moscow, 1964

Biophysics Vol. 28, No. 5, pp. 954-963, 1983
Printed in Poland

0006-3509/83 \$10.00+.00
© 1984 Pergamon Press Ltd

INVESTIGATION OF DIFFRACTION EFFECTS
APPEARING ON PACKING OF HELICAL MOLECULES*

R. A. ABAGYAN, V. N. ROGULENKOVA, V. G. TUMANYAN
and N. G. YESIPOVA

Institute of Molecular Biology, U.S.S.R. Academy of Sciences, Moscow

(Received 11 September 1980)

The paper considers the general problem of diffraction in biological specimens including several levels of organization. Formulae are obtained for diffraction on aggregates of helical molecules in which the size of the cell in the direction of the axis of the molecule does not agree with the period and size of the helix. The formulae obtained fully describe the positions and

* Biofizika 28: No. 5, 897-904, 1983.

Diffra

densities of the reflexio
line diffraction patter
which was earlier not
onal reflexion with $d \approx$
The approach develop
helical structures will be

LOGICAL specimens are
in the structure of a hi
present in weakly defo
part of the following or
following level wou
fulfilled either the bot
sion of this rule is t
organization and the sy
Biological macromole
metry. In this case, on
entary cell naturally
The diffraction patter
ained by the scatter c
the present stage of d
ular level of structu
structural-functional r
ence of unexplained
complicates the p
theory of diffracti
his work considers th
of organization and
analysing the diffrac
theory of diffrac
amplitude of scatter f
the form

$$F_1(R, \Psi,$$

is the number
the scatter factor
order n of the
 z is a whole nu
If the helical tr
limit they are st
in the formula
of molecules:

$$f_j = \sum_i \sum_k \sum_l f_{ijk}$$

and l are Mill
of the cell. d
oids of the

TAB

BIOINFORMATIONAL INTERACTIONS: EHF-WAVES

N. D. Kolbun and V. E. Lobarev

Kibernetika i Vychislitel'naya Tekhnika,
No. 78, pp. 94-99, 1988

UDC 577.31

The informational interaction of the EHF-wave band are discussed. The influence of electromagnetic fields in the millimetric band, which are similar to natural fields, upon human body is studied.

The evolution of life on earth was affected by various environmental factors. Among the most important factors were electromagnetic fields (EMF) and magnetic fields. Studies have confirmed a high sensitivity of biological systems to these fields [2,5].

In principle, each band of electromagnetic waves reaching the Earth's biosphere could have contributed to natural evolution and may affect vital functions [5]. In the past few decades, the theory which assigns a regulatory and informational role to EMF in biological systems has been gaining supporters [5,14,16]. The theory views a biological system as a biochemical complex inseparably linked with internal and external EMF. A concept advanced by Kaznazhev in 1975 (see [6]) represented a biosystem as a nonequilibrium photon constellation maintained by a constant energy influx from outside. Under this concept, EMF quanta are material carriers of information flows in cellular biosystems. EMF flows within a biosystem constitute the informational base of its vital functions; flows of external EMF are the factors regulating (to some extent) the internal information flows.

Differentiation between energetic and informational flows of external EMF has been discussed in [3,5,8]. The energetic actions are defined as the actions introducing a change into biosystem proportional to the amount of energy contributed. An informational interaction of

© 1989 by Allerton Press, Inc.

an EMF with the amount various EME characteris carrying si ergy or mat er boundary on the orde bright line gators (1,3 W/cm². Figu that form t) the atmosph is unevenly from solar r EMF range. and dynamics band. Biolo EMF flows in lowest.

Biologi appear, acco the external transparency density of sc an absolute. t a fraction of sun. In the closely by th T_{eff} in the ra been measured 8000 K [4].

Galactic the natural b: absorbed comp

Other nat

an EMF with a biosystem is one where the effect is not determined by the amount of energy brought in but by specific informational features; various EMF modulations, frequency bands, polarizational and time characteristics, etc., can function as such features. The information-carrying signal, in that case, merely triggers a redistribution of energy or matter in the system and control processes in it [5]. The lower boundary of an information effect is set [8] at flow density (FD), on the order of 10^{-12} W/m² (10^{-16} W/cm²). Apparently, there is no bright line between informational and energetic FD. Various investigators [1,3,8,10] place it in the region between 10^{-7} W/cm² and 10^{-2} W/cm². Figure 1 compares the characteristics of principal EMF sources that form the natural electromagnetic background of the biosphere and the atmospheric transparency to the entire wave band. The atmosphere is unevenly transparent to EMF of different wavelengths. In turn, FD from solar radiation and from other sources is uneven throughout the EMF range. The combination of these factors determines the magnitude and dynamics of natural EM background of the biosphere in each frequency band. Biological systems are likely to be more sensitive to external EMF flows in the frequency bands where the natural field background is lowest.

Biological effects at informational EMF intensities (≤ 1 MW/cm²) appear, according to incomplete data, in those spectral regions where the external background is minimal either because of low atmospheric transparency or a minimal space radiation (see Fig. 1). The spectral density of solar radiation in space matches closely the radiation of an absolute black body at $T = 6000$ K. Radio waves accounts for just a fraction of a percentage point of the total energy radiated by the sun. In the wave band from 0.3 to 10 mm, solar radiation is described closely by the Rayleigh-Jeans law. The effective sun temperature T_{eff} in the radio band is different from kinetic temperature. It has been measured experimentally and for $\lambda = 1-6$ mm varies from 5500 to 8000 K [4].

Galactic radiation does not make any significant contribution to the natural background in the millimetric wave band (EHF), as it is absorbed completely by the atmosphere near $\lambda = 1$ cm (see Fig. 1).

Other natural EMF sources are the Earth's surface and the atmo-

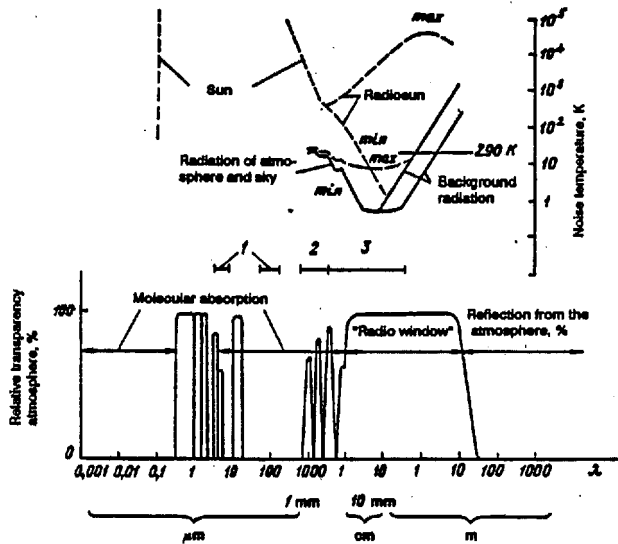

Fig. 1. Natural EMF sources and atmospheric transparency throughout the EM spectral range [12]: 1) frequency "windows" in which BII are observed according to [5]; wavelength bands where biological effects of nonthermal EMF with $FD \leq 1 \text{ mW/cm}^2$ can be observed; 2) data of [7]; 3) data of [1,3,10,13].

sphere. The proper heat radiation from the Earth can be described as radiation of a gray body with $\epsilon = 0.35$ and $T = 288 \text{ K}$. Atmospheric radiation is described by radiation laws of an absolute black body with isolated selective lines of atmospheric gases and water vapors at respective T_{eff} . In EHF-band the effective atmospheric temperature ranges from 100 to 400 K. Throughout the EHF-band, the spectral density of solar radiation is greater by some 12 dB than the proper atmospheric radiation (Fig. 2).

In the range $\lambda = 1 - 8 \text{ mm}$, the atmosphere absorbs EMF selectively, mainly in the bands of molecular absorption of O_2 and water vapors [1,4]. The total attenuation of the radiation on the vertical path in selected bands is as large as 800 dB (Fig. 3). In transparency windows, the attenuation may be just 1-3 dB.

There are several frequency regions in EHF-band that coincide with

Fig. 1
T = 6
Fig. 1
length

atmospheric
minimal
the atmosphere
regions
thesis wa
the course
flows the
near 2.5
tion (MMI
associatio
lattice;
protein
Est
tions (B
are such
synchron
organism

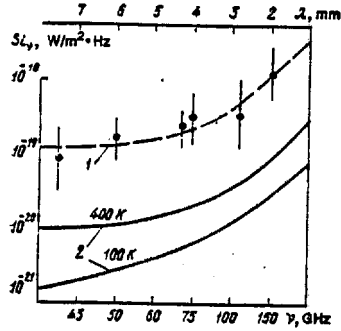

Fig. 2

Fig. 2. Spectral densities of radiation flows: 1) solar at $T = 6000 K$; 2) atmosphere based on data of [4,6].

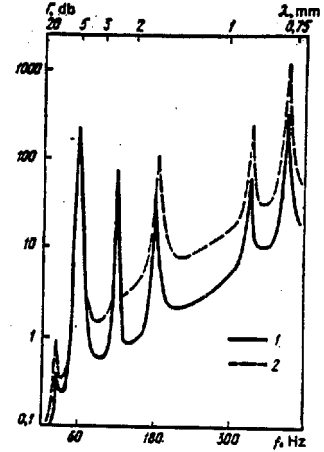

Fig. 3

Fig. 3. Vertical attenuation of MMR as a function of wavelength in clear atmosphere: 1) January; 2) July.

atmospheric absorption bands; the natural field background in them is minimal and is entirely determined by the proper noise radiation of the atmosphere. The spectral FD of the natural background in these regions is 10^{-20} to 10^{-19} $W/(m^2 \cdot Hz)$. Based on this analysis, a hypothesis was advanced postulating that biological systems, adapted in the course of evolution to a low-background level, can respond to EMF flows that rise slightly above the background radiation on wavelengths near 2.5, 1.7, 0.9, and 0.8 mm. Quantum energy of millimetric radiation (MMR) is sufficient for inducing important biological processes associated with rotation of water molecules and oscillations of H_2O lattice, rotation of terminal groups within molecules, conformation of protein molecules, etc. [1,3,10].

Estimating the potential role of MMR in bioinformational interactions (BII), we should note that MMR wavelengths in biological tissues are such that, even in case of a very strong MMR absorption, it can synchronize biochemical processes in single-celled and multicellular organisms.

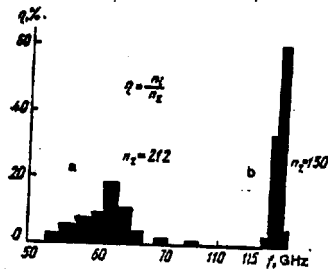

Fig. 4. Relative frequency of sensory response as a function of MMR: a) data of Pyasetskii (see [13]); b) our data.

According to our working hypothesis concerning the biological significance of EMF in EHF-band, MMR on frequencies of atmospheric absorption bands plays an informational role within biosystems and is the material carrier in interactions of biological objects at small distances.

When nonthermal-intensity MMR acted upon selected acupunctural zones in men [13], characteristic sensory response was absorbed with radiation frequencies in the band of 53-78 GHz. We conducted similar tests with 116-121 GHz at radiation FD on the order of 10^{-8} W/cm². The band includes O₂ absorption line with the center near 119 GHz [15]. The He-Gu acupunctural point on the right hand was irradiated. Based on 130 tests, a distribution of the relative number of sensory response was plotted as a function of MMR frequency (Fig. 4). Subjective responses were similar to those described in [13]: parasthesias, sensations of warmth, tingling, etc. Several tests were also conducted where, in similar conditions, a sensory indication of MMR with frequency near 180 GHz was observed.

A special method was developed for the experiment to test the possibility and the range of BII between noncontiguous biological objects. As in [5], electromagnetic wave filters were placed between biological objects. Changes in the state of the object were recorded; the biological objects thus functioned as detectors. The inductor was an operator who had been found in earlier experiments to be capable of inducing sensory reactions in subjects similar to those produced by MMR.

A
ings we
masters
The tra
Copper
in iden
The

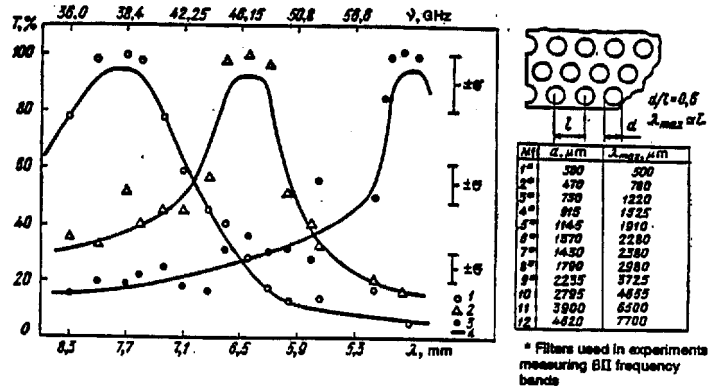

Fig. 5. Transmittance characteristics of gauze bandpass filters: 1) no. 10; 2) no. 11; 3) no. 12; 4) calculated.

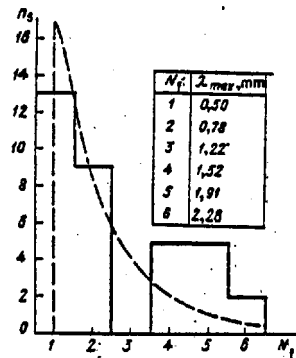

Fig. 6. Distribution of occurrence frequency of sensory reactions with BII through filters with various transmittance maxima.

A series of passband net filters with a honeycomb array of openings were prepared. The filters were made from the same photographic masters by photolithography and etching of 0.2-mm-thick copper foil. The transmittance characteristics of the filters are given in Fig. 5. Copper foil screens were also used. Filters and screens were enclosed in identical opaque paper envelopes.

The subject lay down on a couch; his entire body surface was cov-

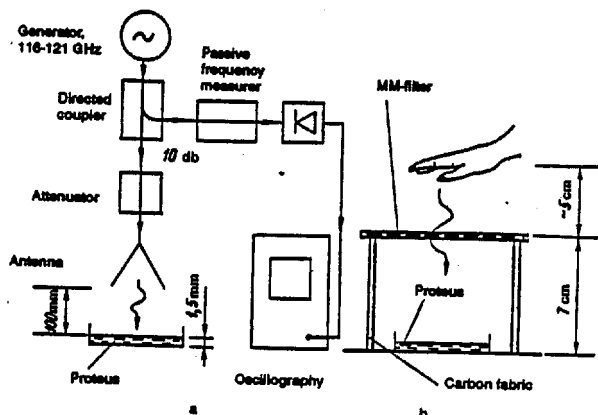

Fig. 7. Setup for irradiation of bacteria (a) and experiments to detect BII (b).

ered with two layers of carbon fabric so that only He-Ge acupuncture point on the right hand was exposed. Since the transmittance of the filters in the short-wave wing at $\lambda < 0.1 < \lambda_{max}$ increases to the level of geometric transparency [9], only one sequence of filters was applied: first, the shortest-wave filter $N_f = 1$, followed by $N_f = 2, \dots, N_f = 12$. Thus, a sequence of filters (F) and screens (S) was formed: $SF_1F_2SF_3SSF_4, \dots$, where the random quantities were only the number and sequence of screens.

Based on the results of the study, a distribution of subjects according to filter numbers was constructed (Fig. 6; the dashed curve indicates the distribution of the random process of origination of sensory responses to presentation ξ).

In the next experiment, we attempted to discover a difference in responses of biosystems to MMR with frequencies 116-121 GHz. Proteus bacteria were irradiated, and placed in a culture medium (Fig. 7a). The hemolytic activity of irradiated bacteria was measured after three hours of incubation in a thermostat, as expressed by the optical density of the specimen. The MMR generator was readjusted in the range of 116.8-120.6 GHz to produce on the culture surface a flux density on the order of $50 \mu W/cm^2$. The radiation power was maintained constant within ± 1.5 dB; the frequency setting error was within $\pm 0.1\%$. Each specimen was irradiated for 180 sec.

F
C
T
I
C
M

The ex values. Tw at each fre ated). Bac It was disc lytic activ GHz (Fig. 8

Simult radiation b (Fig. 7b). maximum at mens were " produced so the human i

The st and attempt ity of such

1. Na tion bands be associat observed ex this view [

2. Th of BII in E

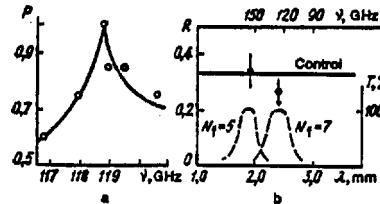

Fig. 8. Probability of hemolytic activity change by low-intensity MMR irradiation (for the threshold of likelihood ratio function $L_0 = 1$) and variation of optical density R of specimens with *Proteus* "irradiated" by human inductor through filters 5 and 7.

The experiment followed a randomized plan for five frequency values. Twenty bacteria samples of the same culture were irradiated at each frequency (an additional 20 control samples were not irradiated). Bacterial concentration in the specimens was 10^8 cells/ml. It was discovered that MMR of 116-121 GHz modified the *Proteus* hemolytic activity, with the maximum probability of the effect at 118.8 GHz (Fig. 8a).

Simultaneously, an experiment was staged to study the effect of radiation by the human inductor on the activity of the same bacteria (Fig. 7b). Two filters (Nos. 5 and 7) were used with transmittance maximum at 1.9 and 2.4 mm, respectively. Through each filter 9 specimens were "irradiated" (with 9 control specimens). The experiment produced some increase of hemolytic activity of *Proteus* irradiated by the human inductor through a filter with $\lambda_{max} = 2.4$ mm (Fig. 8b).

The study made general analysis of the problem of BII in EHF-band and attempted to obtain an experimental confirmation of the possibility of such interactions. The following conclusions were drawn.

1. Natural EM background at frequencies of atmospheric absorption bands in EHF-band has an absolute minimum for $\lambda < 1$ cm. This may be associated with a high sensitivity of biological objects to MMI observed experimentally. Other investigators are inclined to share this view [10].

2. The experimental results are encouraging for the possibility of BII in EHF band. Previously, BII between biological objects have

been observed in the same range of $\lambda = 1.8 - 2.1$ mm [12].

3. Additional careful investigations of the sensitivity of biological objects to MMI in the entire EHF-band with direct registration of nonequilibrium MMI of biological objects will be necessary for definitive conclusions as to the existence of BII in MM band.

REFERENCES

1. "Biological effects of electromagnetic energy in medicine" [Russian translation], IEEE Trans., vol. 68, no. 1, 1980.
2. V. I. Vernadskii, Biosphere [in Russian], Khim.-Tekhn. izd-vo, Leningrad, 1926.
3. B. I. Davydov, V. S. Tikhonchuk, and V. V. Antipov, Biological Effects, Normalization, and Protection from Electromagnetic Radiation [in Russian], Energoizdat, Moscow, 1984.
4. V. V. Zheleznyakov, Radiation of the Sun and Planets [in Russian], Nauka, Moscow, 1964.
5. V. P. Kaznacheev and L. P. Mikhailova, Bioinformational Function of Natural Electromagnetic Fields [in Russian], Nauka, Novosibirsk, 1985.
6. D. Kraus, Radioastronomy [Russian translation], Sov. Radio, Moscow, 1973.
7. V. N. Volchenko, N. D. Kolbun, V. E. Lobarev, and A. P. Belonogov, "Acupunctural effects of EMR of the millimetric band for regulation of the body state in man," in: Applications of Low Intensity Millimetric Radiations in Biology and Medicine: Proceedings of Sixth National Seminar [in Russian], Moscow, p. 97, 1986.
8. G. F. Plekhanov, "Electricity, magnetism, information, and life systems," in: Life Systems in Electromagnetic Fields [in Russian], Tomsk, pp. 3-8, 1978.
9. N. R. Braverman, L. V. Vorob'ev, V. A. Soglasnova, et al., Bandpass Gauze Filters for Long-Wave IR Region [in Russian], Moscow, 1975.
10. Applications of Low Intensity Millimetric Radiations in Biology and Medicine: Proceedings of Sixth National Seminar [in Russian], Moscow, 1986.
11. R. A. Valitova (Editor), Submillimetric Wave Technology [in Russian], Sov. Radio, Moscow, 1969.
12. S. Ya. Turlyagin, "Radiation of microwaves ($\lambda = 2$ mm) by human body," Byul. Eksperim. Biologii i Meditsiny, vol. 14, no. 10(4), pp. 63-72, 1942.
13. E. A. Andreev, M. U. Belyi, V. A. Kutsenok, et al., "Physiological principles of microwave (biological resonance) adjustment of the physiological state of human body," in: Application of EHF Low-Intensity Radiation in Biology and Medicine [in Russian], Moscow, pp. 58-83, 1985.
14. Fundamental Thresholds in Electronics and Related Fields [in Russian], Mir, Moscow, 1981.
15. V. Endo and M. Mizushima, "Microwave resonance lines of $^{16}\text{O}_2$ in its electronic ground state ($X^3\Sigma_g^-$)," Japan J. Appl. Phys., vol. 21, no. 6, pp. L379-L380, 1982.

16. H. Fisher, "Photons as transmitter for intra- and intercellular biological and biochemical communication: the construction of a hypothesis," in: Electromagnetic Bio + Information, Munich-Vienna-Baltimore, pp. 175-181, 1979.

1 February 1987

T. G. Shevchenko State University,
Kiev

ty of bio-
egistration
y for
i.

dicine"
an. izd-vo,

Biologi-
ic Radia-

[in Rus-

nal Func-
ovosi-

Radio,

P. Belo-
regula-
ity
Sixth

, and
Russian],

al.,
oscow,

In
i Rus-

y [in

human
, pp.

hysio-
it of
Low-
, pp.

ls [in

16O₂
21, no.

TAB

BIOLOGICAL ACTION OF LOW INTENSITY MILLIMETER BAND RADIATION

V. V. Betskii and A. V. Putvinskii

zvestiya VUZ. Radioelektronika,
01. 29, No. 10, pp. 4-10, 1986

DC 538.573:61

The possible role is discussed of the strong absorption of millimeter (MM) waves by water molecules in the primary mechanism of the response of biological systems to MM radiation. Data are reported on the interaction of MM radiation with simple water systems. The attention is focused on the effect of convective mixing of water solutions under the effect of low intensity (1 ... 10 mW/cm²) MM waves.

Among the most interesting fields of unconventional uses of electromagnetic waves are medicine, biophysics, and biotechnology. When waves with a large power density are utilized, the useful effect is produced typically by the heating of the material being studied; the effect is determined not only by the geometry of the object, but to a large extent also by the radiation wavelength (λ).

In the past two decades, investigators have been concerned with the low intensity millimeter electromagnetic waves in the millimeter (MM) and submillimeter bands, with waves of a power density of single-digit mW/cm²; the general heating of irradiated material with these waves is small, amounting to some 0.1°C [1-4]. Radiation in MM band is strongly absorbed by various materials. One of these materials is water, which plays an extremely important role in the vital functions of biological systems. For example, a flat water layer 1 mm thick attenuates the radiation at $\lambda \sim 8$ mm by 20 dB, and at $\lambda \sim 2$ mm by 40 dB, i.e., by hundreds of times. The heating of materials in MM band for this reason is superficial, with a large temperature gradient. When human skin is irradiated by MM waves, practically the entire radiation is absorbed in the surface layer of a few one-tenths of a millimeter (the weight content of water in the skin is more than 65%).

Another feature of MM waves is the fact that the energy of an irradiation quantum $h\nu$, even in this short-wave portion of the microwave band, is still smaller than the energy of thermal motion, kT . For the wavelength $\lambda = 1$ mm $h\nu = 1.17 \cdot 10^{-3}$ eV, while at room temperature $kT = 2.53 \cdot 10^{-2}$ eV. The quantum energy in this frequency band is significantly lower not only than the energy of electron transitions (1-20 eV) or the activation energy (0.2-1 eV), but even than the oscillational energy of molecules (10^{-2} - 10^{-1} eV), and the energy of hydrogen bonds ($2 \cdot 10^{-2}$ - 10^{-1} eV). Examples of energies smaller than this quantum are the energy of rotation of molecules around bonds (10^{-3} - 10^{-4} eV), the energy of Cooper pairs in superconductivity (10^{-4} - 10^{-6} eV), and the energy of magnetic ordering (10^{-4} - 10^{-8} eV).

From these energy estimates it follows that MM radiation cannot produce atomic or molecular changes or restructurings. If one takes the analogy with the optical frequency band, such changes would require multiphoton processes; the number of MM radiation quanta that would be necessary for an energy conversion should be 10 or more, which is unlikely. There are two important circumstances that should be taken into account in studies of the effects of interaction of low intensity MM radiation with biological objects.

First, the energy of MM radiation can be transformed to the energy of polar molecules associated with rotational degrees of freedom. The role of such energy accumulators is

© 1986 by Allerton Press, Inc.

performed effectively by polarized water molecules, which have a dipole moment of $1.84D$. In water solutions of various materials, the absorption of microwave energy will also be determined by water molecules and occur as a local process controlled both by the number of water molecules in the solution and the interaction of these molecules with other molecules. Such a selective heating of matter can produce biologically significant effects, even with low MM radiation powers when the overall heating is small and insignificant.

Secondly, the energy of MM waves can be stored on the basis of a different, resonance mechanism, such as the one suggested in [5]. In a nutshell, this hypothesis postulates the following. Biological systems can have polarization (dipole) oscillations in the frequency band 100-1000 GHz ($\lambda = 3-0.3$ mm). The various vital processes in biological cells would provide the energy for locally excited dipole oscillations (biological pumping). By virtue of nonlinear effects of interaction of dipole oscillations and the nonlinear relationship of these oscillations with elastic oscillations, the system can pass into a metastable state, in which the energy will be transformed into the energy of a single type of oscillation. Under the effect of MM radiation, the metastable oscillation can pass into a fundamental oscillation, giving rise to a "giant dipole," which would be a special case of an unusual coherent state of the biological object. The model postulates that such oscillations encompass portions of biological membranes or of biomacromolecules. Such a state is of a single-quantum type, and resembles the low temperature condensation of Bose gas. These two circumstances determine the major trait of MM radiation - the possibility and importance of nonthermal (or low-intensity) biological effects of MM radiation. These effects are observed at radiation power densities of approximately $1-10$ mW/cm², at which the general temperature rise of the irradiated specimen is not greater than $0.1^{\circ}C$, as has been mentioned.

The specifics of the electromagnetic vibrations in the millimeter (and submillimeter) frequency bands would thus be capable of inducing peculiar low-intensity biological effects not accompanied by biologically significant general rise of the temperature of the material irradiated. All experimentally known effects can be divided by way of convention into two groups differing in the mechanism of utilization of the electromagnetic vibration energy: the effects induced by selective space-localized microthermal heating, usually superficial; and the effects caused by frequency-dependent (resonance) type of energy storage.

MAIN BIOLOGICAL EFFECTS OF MM RADIATION

Substantial data have been accumulated in experimental and theoretical studies of biological effects of low intensity MM radiation; in the past few years MM radiation has been used successfully for clinical treatment of various diseases. The primary physical-chemical mechanisms underlying the sensitivity of biological objects to this type of electromagnetic radiation, however, remain an unknown, making their study particularly desirable.

After years of research certain regularities in the interaction with biological objects have been established. In practically important cases the interaction, as mentioned, is not of an energy type, i.e., is not due to a trivial heating of material. One usually speaks of informational interaction (this hypothesis was first examined in [6]). The term can be used legitimately to mean that the radiation of a low intensity can trigger (initiate) a chain of successive responses, accompanied by a transformation of energy and leading to a useful effect, i.e., that the interaction is of a mediated type. This can be applied, of course, to complexly organized (integrated) live biological objects. Not only the frequency-dependent (resonance) but microthermal storage of microwave energy can be informational when interacting with a live organism.

In experiments with microorganisms, animals, or humans, the response can appear as narrow resonance curves tens to hundreds of megahertz wide. The following interesting interaction effects have also been observed experimentally: a) the response has a power threshold (there is a certain minimal power value, after which the effect becomes discernible); b) a stable biological effect is cumulative (the response appears after a certain time following the onset of irradiation - from 15-20 min to an hour); c) the experimental relationships plotting the biological effect versus microwave power have an extended segment (plateau), where the effect is independent of the irradiation intensity from two to five orders of magnitude of power variation); and d) the therapeutic effect in some instances can be improved when MM waves are combined with other therapeutic modalities, such as X-rays or chemotherapy.

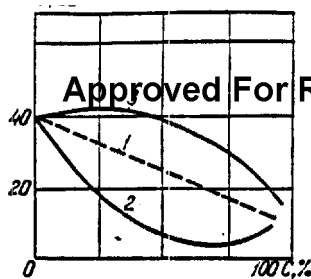

Fig. 1

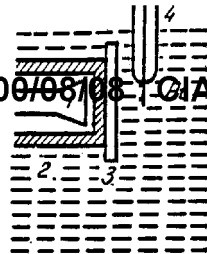

Fig. 2

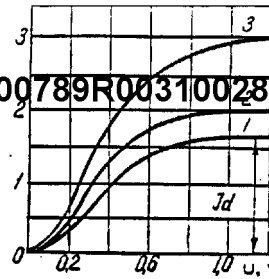

Fig. 3

of microwave electronics (feedback, synchronization of oscillations, etc.). This is the approach developed for example in [1, pp. 127-131].*

We will now briefly describe in qualitative terms the effects of low intensity MM radiation based on the (specific for MM band) selective microheating of water media containing various biological materials. Basic to these effects is the convection of liquid occurring at the phase interface. In planning and conducting the experiments, we were guided by the following key ideas: a) the strong selective absorption of MM radiation by water molecules against the background of low-absorbing components of various liquid media can be responsible for the transport of charged particles and various molecules in such systems; b) biological membranes are the most likely target for low intensity MM radiation in the cell; c) the search for new effects should be conducted on simple biological objects or model systems, even though this reduces the probability of observing frequency-dependent (resonance) effects, which was confirmed in experiments; and d) the primary physical chemical mechanisms of response should be investigated in the skin, thin layers of which absorb MM radiation almost completely.

DISRUPTION OF THE ADDITIVITY OF ABSORPTION OF MM RADIATION BY WATER SOLUTIONS (SEE RELEVANT ARTICLES IN [1,2,3])

Precise measurements of the concentration relationships of the absorption of low intensity MM radiation by water solutions shows that the pattern of absorption of MM radiation varies qualitatively and quantitatively, depending on the type of interaction of water molecules with the molecules of the solvate. Three cases observed at $\lambda = 2$ mm, $P = 1$ nW/cm² are distinguished, depending on the concentration of the solvate as illustrated qualitatively by Fig. 1: 1) the absorption of the electromagnetic radiation by the solution is equal to the sum of absorptions of the solvent and solute; 2) the total absorption is less than the sum of the partial absorptions; and 3) the total absorption is greater than the sum of the partial absorptions. These effects can be explained as follows. When MM radiation is absorbed, electromagnetic energy is pumped into the rotational energy of polar water molecules, followed by the dissipation of energy into thermal energy, as a result of intermolecular interactions. Strictly speaking, the absorption is of a resonance nature: on a fixed wavelength, the radiation is absorbed effectively by a small proportion of water molecules whose frequencies of rotational motions are close to the frequency of incident radiation. As the frequency of the external field is changed, a different group of molecules takes part in absorption of the radiation, in conformity with the distribution of water molecules according to the rotation frequencies. Experimentally, it is impossible to determine the resonance nature of such absorption because of the effective mechanism of thermal scattering of energy that would occur within the time of the order of 10^{-9} - 10^{-10} sec. In the first case of absorption, illustrated by Fig. 1, water molecules practically do not interact with molecules of the solute; in the second case, some of the water molecules lose rotational mobility as a result of intermolecular interaction (the molecules of bound water absorb MM radiation less than do molecules of free water), i.e., the total absorption decreases; in the third case, the intermolecular interaction is such that it increases the rotational mobility of water molecules, leading to an additional increase of the total absorption. From relations similar to those given in Fig. 1 it is thus possible to judge about important parameters, such as degree of hydration, the reactivity of mole-

*See also the paper by M. B. Golanta and T. E. Rebrova in the current issue.

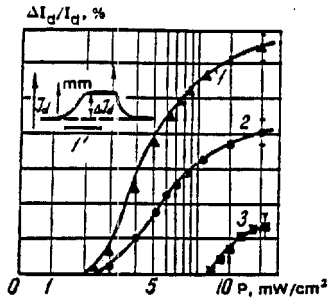

Fig. 4

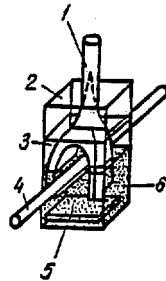

Fig. 5

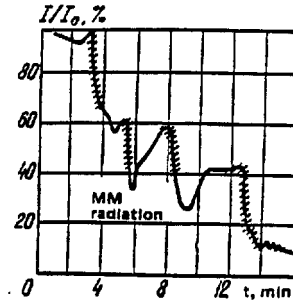

Fig. 6

cules in water solution, etc. These effects could also be of a practical value in engineering processes (especially in the pharmaceutical industry) for monitoring solute concentrations.

These peculiar properties of the molecules of free and bound water in MM wave band gave an impetus for developing the theory of dielectric relaxation of polar molecules and creation of refined molecular models; this in turn yielded valuable information for understanding the structure and properties of water in complex compounds. Interesting information on this matter can be found, for example, in [2,7].

EFFECTS OF MM IRRADIATION OF WATER SYSTEMS

By strong interaction with water molecules, MM radiation affects the properties of water, both as the external and internal environment of live cells. The early experiments with water systems revealed the effect of convection. The picture of water convection in rectangular quartz or acrylic plastic trays irradiated with low intensity MM waves was studied by optical methods of phase contrast and holographic interferometry [8]. The varied methods of irradiation (placing the irradiating horn at the lower side walls or above an open water surface) produced water motions conforming to the mechanism of interphase convection (i.e., convection caused by gradients of surface tension forces) at a power level below 1.0 mW/cm^2 . The convection usually encompassed the entire volume of a tray (up to 2 ml) and had a fluctuational pattern. The dependence of convection intensity on MM radiation power was determined by a polarographic technique. The experiment setup is illustrated by Fig. 2, where 1 is radiation horn, 2 is a teflon cartridge, 3 is thermochromic liquid crystal film, and 4 is platinum microelectrode. As is well known, the limiting current I_d reducing the substances dissolved in water is determined by the thickness of the diffusional layer on the electrode surface, and therefore is highly sensitive to convection in the solution. Polarograms of reduction of O_2 in water solution is shown in Fig. 3: 1) at 18°C with no mixing of the medium; 2) at 23°C also with no mixing; 3) at 18°C with mixing. When MM radiation was started, at the instant marked by the arrow, I_d was observed to grow both for O_2 and for Cd^{2+} (Fig. 4, curves 1 - MM radiation (1 M KCl); 2 - MM radiation (10^{-3} M CdCl_2 , 1 M KCl)). In this experiment the thickness of the layer between the electrode and the wall (the thermochrome film), through which the radiation was conducted, was 2 mm, so that direct action of the microwave field or thermodiffusion on the electrode was ruled out. This effect was produced by interphase convection, due to forces of surface tension, not only in the irradiated zone, but at the water-air interface as well.

Judging by the color of the thermochrome film, the heating even at 20 mW/cm^2 was not greater than 0.2°C . Obviously, it is the interphase convection which is the main mechanism for removing the heat from the irradiated zone. It is of interest also to compare the microwave action with simple heating of the wall with IR radiation, which also induces convection (Fig. 4, curve 3 - IR radiation (10^{-3} M CdCl_2 , 1 M KCl)). In the latter case, the effect was observed only with the calculated heat flux value of not less than 15 mW/cm^2 . This can be explained by the fact that microwave power is released directly in the solution, while with IR radiation, the heat flow from the tray wall is limited by the low thermal conductivity of water impeding convection.

An interesting demonstration of the convective mixing in the tray with MM radiation

can be observed in experiments with chlorine plastic radiator of a special shape (fork) used in [9] to study the frequency-dependent effects of MM waves (Fig. 5, where 1 is the fork radiator*; 2 is tray; 3 is water; 4 is the light beam; 5 is stirrer; and 6 is ink). For mixing in the inner volume of the tray, into which the fork was placed, a vibrating plate (50 Hz) was placed near the bottom of the tray. An ink drop was introduced through a thin needle to the bottom of the tray, and the intensity of the light beam passing through the space inside the "fork" was observed.

When the vibration intensity of the stirrer was not too large, the ink did not spread throughout the entire volume, leaving the top portion of the tray clear. After MM radiation was turned on, the light transmittance decreased (Fig. 6), and the movement of the ink upward along the teflon surface could be observed visually. Remarkably, when microwave radiation was turned off, the ink/water interface again leveled and light transmittance was partly restored. Importantly, the convection causing the mixing of ink in these experiments was observed when the power in the channel was just 15 mW (the irradiator area was 5 cm²).

The experiments with water and water solutions in trays commonly used in studies of the biological effects of MM radiation thus reveal convectional motion for radiation intensities below 10 mW/cm², which is usually described by many authors as "nonthermal." Such convection caused by the forces of surface tension at the phase interfaces can be either localized or encompassing the entire volume of the tray. Many biochemical and particularly membrane processes are known to be sensitive to the mixing of the medium. It has been determined experimentally, for example, that low intensity MM radiation can accelerate the active transport of ions of Na⁺ (P ≥ 1 mW/cm²), modify the erythrocyte membrane permeability to K⁺ ions (1-5 mW/cm²), accelerate the peroxide oxidation of unsaturated fatty acids in liposomes (≥1 mW/cm²), increase the ionic conductivity of two-layer lipid bilayer membranes (≥10 mW/cm²), etc. [10,11]. The convection which removes diffusional restrictions in the medium and inside the intracellular compartments can thus be a primary mechanism of the action of MM waves on the vital processes.

Another effect has a direct relation to microwave technology. It has been noted that, as water flows through a thin glass capillary inserted into a rectangular waveguide in the area of the maximum E-field on H₁₀ wave, the water flow is affected by the intensity of the wave passing through the waveguide. It has been determined that MM radiation speeds up the water flow; this allows using the capillary as an elementary thermoviscosimetric sensor of microwave energy [12]. It seems that MM radiation, being absorbed in the thin near-wall layer of the capillary, affects the cohesion of the water with the wall, modifying the motion of liquid through the capillary.

The sensitivity threshold of biological objects to low-intensity continuous MM radiation is 1-10 mW/cm². Some of the effects are due to the substantial selective absorption of this radiation by water molecules, leading to liquid convection in this specimen. Convection is also responsible for variations in the transport of charged particles and various materials through membranes, which is of a major biological importance. These effects must be taken into account when using low-intensity MM radiations for clinical treatment of various diseases. The experiments on simple and model objects confirm the idea that the frequency-dependent (resonant) effects of MM radiation are a property of complexly organized (live) biological objects.

REFERENCES

1. N. D. Devyatkov (Editor), Uses of Low-Intensity Millimeter Radiation in Biology and Medicine [in Russian], IRE AN SSSR, Moscow, 1985.
2. N. D. Devyatkov (Editor), Nonthermal Effects of Millimeter Radiation [in Russian], IRE AN SSSR, Moscow, 1981.
3. N. D. Devyatkov (Editor), Effects of Nonthermal Millimeter Radiation on Biological Objects [in Russian], IRE AN SSSR, Moscow, 1983.
4. H. Froehlich and F. Kremmer (Editors), Coherent Excitations in Biological Systems,

*The unit was kindly provided by Dr. F. Keilmann (Max Planck Solid State Institute, Stuttgart, FRG).

Springer Verlag, Berlin, 1983.

5. F. Froehlich, "Long-range coherence and energy storage in biological systems," *Int. J. of Quantum Chemistry*, vol. 11, pp. 641-649, 1968.
6. A. S. Presman, *Electromagnetic Fields and Live Nature* [in Russian], Nauka, Moscow, 1968.
7. V. I. Gaiduk, "Dielectrical relaxation in an ensemble of linear molecules for various collision statistics," *Izv. VUZ. Radioelektronika**, vol. 28, no. 11, pp. 1366-1371, 1985.
8. I. G. Polnikov et al., "Hydrodynamic instability at phase boundaries in the absorption of low-intensity MM radiation," in: *Uses of Low-Intensity Millimeter Radiation in Biology and Medicine* [in Russian], IRE AN SSSR, Moscow, 1983.
9. F. Keilmann, "Experimental RF and MW resonant nonthermal effects," in: *Biological Effects and Dosimetry of Nonionizing Radiation*, M. Grandolf, S. Michaelson, and A. Rindi (Editors), Plenum Publishing Corporation, New York, 1983.
10. O. V. Betskii, K. D. Kazarinov, A. V. Putvinskii, and V. S. Sharov, "Convictional transport of substances dissolved in water as a possible mechanism of acceleration of membrane processes by MM radiation," in: *Effects of Nonthermal Millimeter Radiation on Biological Objects* [in Russian], IRE AN SSSR, Moscow, 1983.
11. S. G. Mairanovskii et al., "Polarographic study of the influence of low power MM radiation on rate of pyridine protonization in a water medium," *Dokl. Akad. Nauch. SSSR*, vol. 282, no. 4, pp. 931-933, 1985.
12. O. V. Betskii, K. D. Kazarinov, A. V. Putvinskii, and V. S. Sharov, "A method for measuring the power of microwave radiation," *USSR Authors' Certificate no. 1101750*, *Byulleten Izobretenii*, no. 25, 1984.

24 March 1986

Contents

VOLUME 29

NUMBER 10

1986

RADIOELECTRONICS AND COMMUNICATIONS SYSTEMS

PAGES
RUSSIAN/ENGLISH

SPECIAL ISSUE

MICROWAVE ELECTRONIC DEVICES

Editor's forward. I. V. Lebedev.....	3	1
Biological action of low intensity millimeter band radiation. O. V. Betskii and A. V. Putvinskii.....	4	2
Similarities between living organisms and certain microwave devices. M. B. Golant and T. B. Rebrova.....	10	8
Modeling of nonlinear problems in semiconductor microwave electronics. Yu. L. Khotuntsev.....	20	16
Main trends in the modeling of submicrometer metal Schottky gate field-effect transistors (a review). G. V. Petrov and A. I. Tolstoi....	28	23
Design elements and efficiency of the oscillating systems of solid state microwave oscillators. S. A. Zinchenko and E. A. Machusskii.....	43	36
Frequency dependence of the modulation sensitivity of Gunn oscillators. V. N. Dubrovskii and A. S. Karasev.....	50	43
Calculations of diode operation in a high-power upconverter. Yu. G. Tityukov and V. A. Yakovenko.....	55	49
Study of the methods of solution of a self-congruent problem in O-type devices with a periodic structure. A. V. Osin, V. V. Podshivalov, and V. A. Solntsev.....	61	55
Power summation algorithm used for study of vacuum tubes with prolonged interaction. Yu. L. Bobrovskii and S. R. Zaremskii	66	60
A multiperiod numeric model of a crossed-field amplifier. A. A. Terent'ev, E. M. Il'in, and V. B. Baiburin.....	72	66
Unconventional uses of retarding systems. Yu. N. Pchel'nikov.....	79	72

Brief Communications

Numeric modeling of microwave limiter diode. N. I. Filatov and A. S. Shnitnikov.....	84	76
Optimization of the energy characteristics of varactor microwave mixers. A. E. Ryzhkov and I. E. Chechik.....	86	80
Optimization of phase and amplitude-frequency characteristics of a microwave semiconductor amplifier. V. I. Kaganov and S. N. Zamuruev.....	90	84
Efficiency of matching circuits in solid state microwave oscillators. E. A. Machusskii.....	92	88
Solid state waveguide phase shifter with a resonant grating as a control element. A. S. Petrov, V. V. Povarov, and I. V. Lebedev.....	94	90

EDITOR'S FOREWARD

I. V. Lebedev

Izvestiya VUZ. Radioelektronika,
Vol. 29, No. 10, p. 3, 1986

This special issue of the journal, dedicated to microwave electronics, open with two articles discussing the biological effects of radiations in the millimeter band. Studies in this field in the USSR and abroad have for a number of years attracted the interest of diverse specialists - physicists, developers of vacuum and solid-state microwave devices, biologists, and medical scientists. The data and the possible explanations offered in these papers (some of which may be debatable) will promote further progress in this vital area, which stretches far beyond the conventional framework of electronics.

As usual, much attention in this issue is given to solid-state microwave devices. One of the review articles discusses the general aspects of computer simulation of non-linear problems of semiconductor microwave electronics; another review deals with the current problems in modeling of submicronic field-effect transistors. In this connection, one should emphasize the contribution likely to be made in this area by large-scale applications of personal computers, as well as big mainframes, so as to hasten the creation and improvement of new solid-state microwave devices.

Some of the articles and communications describe the current problems in increasing the power of solid-state microwave devices and units. There is a paper presenting non-linear analysis of a semiconductor delimiter - one of the less studied types of solid-state microwave devices. Among other results published is research connected with the development of various types of solid-state oscillators, amplifiers, converters, and control units. The dramatic advances we are currently witnessing in microwave transistors, especially field-effect transistors, and their expansion into the millimeter wave bands, offer a new perspective for the creation of various radio engineering systems. The interpenetration of the methods of microwave technology and superhigh-speed integrated circuits is further expanding the capabilities and applications of solid-state electronics.

Lively research is under way also in the field of vacuum microwave electronics, and in particular, the development of effective methods of computer analysis and synthesis, especially the specific problems in the development of O-type and M-type devices. One paper discusses the application of retardation systems in fields of engineering not immediately connected with electronic devices. The vast store of experience accumulated with microwave electronics can be productively utilized in other spheres of the economy.

Some of the important trends of microwave electronics are not covered in the issue, especially the development of monolithic integrated microwave devices and units, which offer broad opportunities for microminiaturization of microwave technology, raising the reliability and cost effectiveness of these products. This and other areas of current importance will be covered in the future issues of the journal.

© 1986 by Allerton Press, Inc.

SIMILARITIES BETWEEN LIVING ORGANISMS AND CERTAIN MICROWAVE DEVICES

M. B. Golant and T. B. Rebrova

Izvestiya VUZ. Radioelektronika,
Vol. 29, No. 10, pp. 10-19, 1986

UDC 538.56:57:621.385.6

Vital functions of live organisms are discussed on the basis of published experimental data concerning the effects of lower-power millimeter-band electromagnetic waves on these organisms. Analogies with operation of microwave devices are drawn.

In [1] the possibility was discussed of applying the concepts of radioelectronics and cybernetics to medical and biological problems. The study was concerned with the general aspects of organization of the control of complex systems, as they refer to utilization of low (nonthermal) power millimeter-band waves of electromagnetic radiation (EMR) in order to mobilize forces in a live organism, to eliminate disbalances in its functioning, or to prepare the organism for future detrimental impacts.

Parallels between the EMR effects on live organisms [2] and general operation regularities of information systems have been drawn in [3,4]. These regularities, which determine the choice of the oscillation power and frequency, the requirements to oscillation stability, radiation site and time, etc. [5], proved important in the EMR uses for medical treatments and in biotechnology. This universality is connected with the fact that the general patterns of operation of information systems apply to different organisms and actions. Mechanisms triggered by control signals can differ substantially, depending on the information content of the signals and the nature of the objects at which they are directed.

Can an analogy with the organization principles of a microwave device be useful for understanding the operation of the informational processes in live organisms? We believe that it can, although such an analogy cannot be as complete as when one analyzes the general patterns of operation of information systems. Here one can - cautiously - compare the characteristics observed in experiments on live organisms with the characteristics of microwave devices and units. Ample experience accumulated after five decades of development of microwave technology can give clues to interpretation of the results. This possibility is extremely valuable because of the insurmountable obstacles faced by attempts at direct observations in this area.

RESONANCE IN CELL MEMBRANES

Considerable biological effects in various parts of the body, often quite remote from the irradiated part of the body surface, can be produced by an infinitesimal EMR power. This observation initially suggested the possibility of some informational function performed by irradiation. What elements in the body respond to signals of such a high frequency?

Theoretical analysis of the experimental facts connected with the EMR effects in live organisms indicated early on that it is cells and cell elements, and especially membranes, that respond to EMR action [6]. The fact that a very low power was sufficient for an informational impact [NOTE. Simple estimates based on the total number of cells in the human body (10^{14} - 10^{15}) and the general thermal output of the body (measured by hundreds of watts) show that mean power output of a cell is 0.5-5 pW; for bacteria, based on the ratio of an organism's volume to the mean volume of the human cell, this power is lower by a factor of 10^3 . The density of the power flow absorbed by a cell during irradiation and sufficient for producing the biological effect (see, e.g., [3,9]), adjusting for absorption]

© 1986 by Allerton Press, Inc.

tion in the environment, is not larger than 0.1 of these quantities. Studies of the information effects produced by impulse signals [10] suggest that the mean energy of the exciting signal can be even lower, at least by an order of magnitude] suggested two alternatives: either the cells, under certain biological conditions, exist in a state close to a triggering threshold of signal generation or, even before the EMR action, such generation takes place in the cells. In the former case, the generation of an information signal by the cell is similar to signal amplification in a regenerating amplifier [6]; in the latter, the function of the EMR is to synchronize signals generated by a large number of oscillators [7]. In view of the instability of regenerating amplifiers, as contrasted against the stability and reliability of functioning of live organisms, the mechanism determined by synchronization of a large number of oscillations appears more natural.

As has been demonstrated in [11], a notion of such oscillators is provided by the fine structure of the spectra of EMR-induced effects [8,12,13] (Fig. 1), due to the possibility of inducing in lipid cell membranes acoustic waves of the whispering gallery (waves not radiated into the external environment because of the complete internal reflection). Data in [14] on the elastic modulus of distension of cell membranes K_e ($K \sim 0.45$ N/m) and the thickness Δ_M of their hydrophobic region ($\Delta_M \approx 3 \cdot 10^{-9}$ mm) make it possible to estimate the velocity v_z of acoustic waves traveling along the membrane

$$v_z \approx (K_e / \rho \Delta_M)^{0.5}, \quad (1)$$

where ρ is the density of the lipid (fatty) layer, which for the evaluation can be set at 300 kg/m^3 .

The value of v_z computed with (1) is approximately 400 m/sec. The membranes of certain cells and subcellular elements are cylindrical [15,16]. If the oscillations are excited along the perimeter of the side surface of the cylinders, their resonance condition will require that the parameter πd (where d is the diameter of the cylinder) be equal to an integer N of the length of acoustic waves Λ

$$\Lambda = v_z / f \quad (2)$$

(where f is the oscillation frequency),

$$N = \pi d / \Lambda, \quad (3)$$

$$f = N (K_e / \rho \Delta_M)^{0.5} (\pi d)^{-1}. \quad (3')$$

The frequency diversity Δf of two neighboring resonances corresponds to a change of N by ± 1 and is equal to

$$|\Delta f| = v_z / \pi d \approx (K_e / \rho \Delta_M)^{0.5} (\pi d)^{-1}. \quad (4)$$

Cellular membranes are polarized, and each has a constant potential difference corresponding to a field intensity of the order of 10^7 V/m. The acoustic vibrations deforming the membrane, therefore, induce a variable electric field, forming an acoustic-electric wave. The spatial period of the variable component of the electric field is equal to the wavelength of acoustic oscillations determined by (2). For example, for *E. coli*, which has the diameter of about $0.65 \mu\text{m}$ [15], when the excitation is produced by wavelength in the free space of $\lambda \approx 6.5$ mm (corresponding to $f \approx 46.1$ GHz), the wavelength in the membrane Λ will be approximately equal to 100 \AA . The electrical length N of the perimeter, according to (3), is close to 200. The variation $\Delta \lambda$ of the wavelength in the free space or λ corresponding to Δf , defined by (4), is $\Delta \lambda \approx 3 \cdot 10^{-2}$ mm. This practically coincides

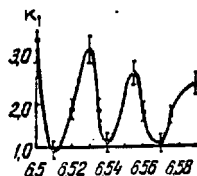

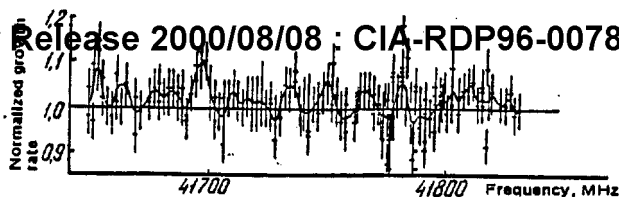

Fig. 2

with the experimental data [8] (Fig. 1).

Figure 1 plots the synthesis induction coefficient K_1 vs. λ during irradiation of *E. coli* culture. Similar estimates for yeast cultures based on spectra published in [12] (Fig. 2) show that this spectrum represents the oscillations of the outer membrane, while the spectrum published in [13] (Fig. 3) refers to vibrations of mitochondria membranes.

Figure 2 plots the normalized rate of growth of the yeast culture irradiated by EMR vs. f ; Fig. 3 plots the dependence on λ of the change in the number of carrier sites after mice are exposed to EMR combined with X-rays (the curve PMD + R), as compared with change in the number of carrier sites after irradiation with X-rays alone (curve R): K is the control.

It is not only the quantitative fit of the calculated and experimental spectrum that is essential. The cognitive significance of this analysis is even more important.

First of all, it clarifies why the lines in the spectra are narrow despite the substantial losses in the biological media, and explains the presence of many bands in the spectra which correspond to similar biological effect. Both these observations are attributable to the fact that cell membranes exposed to acoustic vibrations are resonance systems in which a large number of oscillation types can be induced; some of them (with similar values of N) are similar in the type of fields that are induced. In the analysis of the effect spectra shown in Figs. 1-3, one should take into account that these are substantially nonlinear relationships between the bodily effects and the information parameters. It should also be noted that in the elementary case of a cylindrical membrane taken for illustration, we discuss types of oscillations that differ in just one parameter N for the sake of clarity. In reality, membrane shapes can be complex with corresponding vibrations characterized generally by more than one parameter. For example, in Fig. 3, two series of lines with a similar period can be distinguished, which are shifted relative to each other. Different series of resonance bands can correspond to different cell membranes (see below, the last section) and can be stimulated in different subbands.

It becomes also clearly why the biological effect of EMR on a healthy cell is weak (within the natural scatter of the functional indicator), and becomes manifested only after several irradiation sessions [17]. The calculated value of wave velocity $v_z \approx 400$ m/sec corresponds to the deceleration of the electromagnetic wave by almost a factor of one million (reduction of the wave velocity compared with the speed of light in vacuum). The field is pressed tight to the membrane: the distance from the membrane surface at which the field amplitude is reduced by a factor of e for a wave $\lambda = 5$ mm is approximately equal to 10 \AA . In order for such a system to become connected with a wave propagating in the outer environment, special elements of connection are necessary. The organization of these elements is discussed in the next section. We will merely note here that such connection elements arise only under unfavorable biological conditions, to which cells or cell systems respond by restructuring. Under normal conditions the membranes radiate almost no millimeter waves; accordingly, they can hardly perceive any external radiation. The highly organized energy of microwave vibrations is not wasted by the body; in terms of energy loss, there is no substantial difference between generation and regenerative amplification.

Another theoretically and practically important experimental fact also becomes explicable: under the same experimental conditions, it is not only the fine structure that is characterized by an exceedingly high reproducibility, but also the frequency values at which specific biological effects are observed, despite the fact that the dispersion of the cell sizes and subcellular elements is fairly large. This happens because the value of v_z , by virtue of (1), is affected by several parameters (the calculated value of $v_z \approx 400$ m/sec is found for mean values, and is itself an averaged estimate). By virtue of

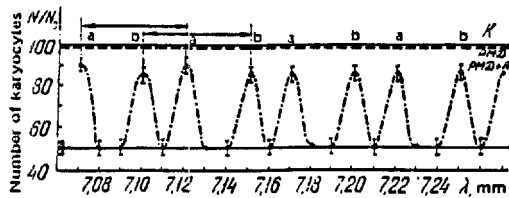

Fig. 3

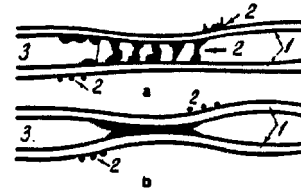

Fig. 4

(2), λ for a fixed f is proportional to v_z , and so for given N and f , the value of d (see (3)) will also vary in proportion to v_z . Changes in the number of wavelengths N (for a fixed f) on the perimeter of a membrane are unlikely under the conditions of the experiment. The membrane is built successively of separate "blocks" - molecules. In the construction of cellular structures, one error occurs per 10^3 construction motions [18]. On the other hand, there is a very small number of molecules per one wavelength [16], so that even when thousands of wavelengths can be fitted along the membrane perimeter, a change of the number of molecules along the perimeter of a membrane in the course of its construction is practically ruled out for any significant number of cells. If the number of molecules is the same, the values of v_z and λ , in conformity with the analysis of (1) and (2), and the parameters appearing in (1), will be affected solely by the density of the packing of molecules; the changes in this density will produce variations of λ and d proportional to one another.

The informational action of EMR on cells appears to be connected with f largely through N , because it is N which determines the character and direction of forces in the natural system of coordinates tied to the membrane. In particular, the fine and flexible control of cells functions, by varying f can be due to the fact that with a large number of oscillations characterized by small variations of N and respective field configurations, a fairly smooth regulation of cellular processes can be achieved. The excitation of membranes has been studied extensively (see, e.g., [16]). In view of the small value of v_z , the mechanism of long-term or multiple interaction of the variable electric field of the membrane with charges connected with protein molecules described in [16] seems probable. In electronic devices, long-term and multiple interactions of charges with a microwave field are quite common (see, e.g., [19]). In resonance systems closed in field and in current, such as the electrodynamic system of a multiresonator magnetron, excitations are quite easy to induce (it is this kind of system that a membrane should provide for the oscillations closed in a ring and excited in it). The current necessary for stimulating oscillations would be determined by the quality of the energy loss in the system for a certain amplitude of the microwave field and the energy released into this field by the charges. The charges, connected with protein molecules oscillating at their resonant frequencies (due to the metabolism energy), have, because of a large molecular weight of protein molecules, considerable stored energy which they can pass on to the membrane's microwave field in the course of interaction. The oscillations of single protein molecules can be likened to vibrations of a spring which responds by attenuating vibrations at the natural resonant frequency to any nonperiodic perturbation. For coherent vibrations to be excited in a membrane, the vibrations of the individual oscillators, however, should be co-phasic. Since the polarization of membranes is necessary for acoustoelectric waves to be excited in them it is necessary for signal generation in the membrane. This process can be depicted as the phasing of protein oscillators linked with the membrane by the acoustic component of the wave field associated with transfer of energy of these oscillators to the wave; the electric component of the wave interacts with the charges associated with protein molecules. Another legitimate hypothesis is that the mechanism is inverse: the phasing of the vibrations of the electrical component of the wave field in the membrane and the transfer of the energy of oscillators of its acoustic component.

The energy spent to phase the vibrations of the oscillators is small compared with their own energy [7]. Since losses in the lipid membrane are relatively small, we can conclude that a small number of protein oscillators would be sufficient for signal generation with this mechanism. When the cell, however, is subjected to unfavorable impacts (making it necessary to radiate signals controlling the recovery processes), proteins from the cytoplasm are drawn toward the membrane and become associated in it [20]; this should increase the current and, therefore, the magnitude of oscillations induced in the membrane.

CONNECTION BETWEEN ELECTROMAGNETIC OSCILLATIONS EXCITED IN CELL MEMBRANES AND THE ENVIRONMENT

In a normally functioning organism the electromagnetic vibrations induced in cell membranes practically do not interact with the environment, because the fields are pressed tight to the membrane surface. EMR irradiated into the environment or perceived from outside are negligibly small. While any connection with the environment would mean a waste of energy for a normally functioning organism, it may become necessary when the normal functioning of cells is disrupted. It could help processes aimed at eliminating the disruptions or adapting to changed functional conditions.

How are vibrations in the membrane connected with the environment? Of interest in this context are the so-called temporary structures that appear on membranes only during the restructuring of the function and later disappear. Could these structures function as communication elements? Experience with multiresonator magnetrons, where the field structure, to some extent, is similar to the above-described field structure in an excited membrane (an integral number of lengths of slow waves in both cases fit into the circle of the resonating system), suggests that interaction with this field could be arranged with the aid of a probe connected with the field of one of the standing waves in the system. The communication elements, placed at a distance equal to the wavelength of the slow wave from one another, introduce a greater load into the system; they effectuate the connections with the crests of waves corresponding to the same phase of the oscillation. A study of the behavior of cells exposed to unfavorable factors under an electron microscope showed [20] that membrane surfaces developed septa - periodic protrusions shifted relative to each other by approximately 100 \AA , i.e., the value of the slow wavelength λ estimated in the preceding section. For evaluating the size of these protrusions it should be noted that if the oscillations are moved away from the membrane (where they occur in the same phase) to a distance of just about $\lambda/2\pi$ from the surface (i.e., a distance of about 10 \AA), then an ordinary time-variable field will be excited outside of the membrane. A decrease in the amplitude of this field with the increased distance from the site of excitation will no longer be associated with the total internal reflection but mainly with the active losses in the environment. It is through these protrusions or septa that the primary contact occurs between the membranes, brought closer together by the unfavorable impacts (Fig. 4): the protrusions reduce the degree of field attenuation since the distance from the surface at these points is shorter; as a result, interaction can be established at a greater overall distance. Figure 4 [20] is a diagram of the process of reactive restructuring of membranes after being exposed to a variable field: a) formation of protrusions; b) pulling together of membranes; 1) membranes; 2) material adhering to the membrane; and 3) intermembrane gap.

One might think that since, according to (2), λ is frequency dependent, a specific distance between the protrusions, if it could be tied to the field configuration, would indicate that the communication between them is of a narrow band type. The real number of protrusions in periodic sequences, however, is relatively small (up to 5-6) and they vary noticeably in shape [20]. They can be used, therefore, for communication in a very broad frequency band for interseptal distances equal to the mean λ for this band. Besides, variations in the degree of connection in a broadband affect little the informational effect. The latter depends little on the signal amplitude [4]. The degree of connection in case of an underloaded generator changes the radiated power relatively slowly [19].

The existence of a connection between the periodic membrane structures and the electromagnetic field is supported also by the fact that these structures arise in areas where membranes cup out; this cupping out of itself provides some connection (although very weak in the absence of septa) between the high-frequency fields in the membrane and in the environment.

Similar results have been obtained in a different way in [21]. The study was concerned with the interaction between cells (erythrocytes) in a medium into which long-fiber polyethylene oxide molecules were introduced. In terms of the above scheme, these molecules could operate as communication elements for removing the microwave energy from the membrane surface. After the molecules were introduced into the medium the maximum distance between the cells at which an intercellular interaction could be observed greatly increased. The optimum concentration of polyethyloxide molecule (corresponding to the maximum intercellular interaction) was achieved with an intermolecular distance of about 40 \AA . It should be noted that, first, the ends of all molecules are not situated in the same

plane and are not in contact with the membrane surface. The mean distance between them, measured along the membrane surface, should be close to the distance measured perpendicular to this surface. Secondly, the region of a field with a noticeable amplitude (smaller than the amplitude at a surface by not more than by a factor of 10) is greater than $\lambda/2\pi$ by nearly 2.5 times and equals approximately 40 Å. This means that the field region with the larger amplitude includes molecules separated by distance of about 100 Å rather than just 40 Å. These experiments, too, confirm that the optimal spacing between communication elements is close to the length of the slow wave λ estimated above.

The match of the data of three qualitatively different methods of study of the position of elements which could serve for communication between the cell environment and the oscillations in the membrane supports the hypothesis that variable fields are induced in the membrane and the possible system of connection with these membranes.

A minor asymmetry can be observed in a normally functioning cell as well. It may be responsible for the observed slow reconstruction of function in healthy cells exposed to external EMR (which probably occurs during several irradiation sessions). The function is modified within the range that is characteristic of the biological species concerned.

CONTROL OF CELLULAR PROCESSES BY MEMBRANES

In order to complete this description, we will discuss in a general form how the information carried by configurations of fields induced in a membrane can cause modifications in the cell and how it can be transmitted within the body.

In [23] a theoretical analysis of the effects of ponderomotive forces excited by variable electromagnetic fields was performed. It studied the influence of these fields on the formation of so-called cytoskeleton in the cell - a net of threadlike formations capturing specific types of molecules and transporting them to the site of their action. Once the cellular structure has been built, the cytoskeleton decays. In [18] this theory was refined, specifying that the address of each action is determined by the intersection of the threadlike structures. The authors of [18,23] rested their hypothesis on the experiments in the IR band, but extended (without special analysis) their conclusion to EMR actions in live organisms. At first glance, the hypothesis agrees with the conclusions of the preceding sections: a field configuration induced in a membrane by EMR causes filiform formations in the cell in conformity with the type of the oscillations induced. The cross-points of the filiform formations in the cell are shifted when the type of oscillation is modified, which, according to [18], should change the sites and type of the processes that occur. Whether the signals are generated by the organism or received from outside in this case is immaterial.

This description, however, is at variance with microwave electrodynamics. Cells are not larger than a few micrometers in size and are filled with a medium which has a dielectric constant close to that of water. A minimal cross section of the waveguide channels for millimeter waves in such a medium should be larger than the cell size by many times, and no hypothesis compatible with the real data on the dielectric properties of elements inside the cytoplasm can justify the possible formation of channels conducting EMR in areas occupying just a portion of a single cell.

A more likely explanation can be based on processes on the surfaces of membranes. There is a large number of membranes in a cell: in addition to the external membrane, which is the cell's sheath (the so-called plasmatic membrane), subcellular particles are also surrounded by their own membranes. Among these are the mitochondria (which function as the powerhouses of the cell) and the lysosomes (which contain the enzymes splitting proteins, nucleic acids, and other substances). Additional membranes develop and decay in the course of a cell's functioning when the cell is exposed to unfavorable impacts. Multilayer membrane structures and small bodies are formed sometimes to provide a contact [20]. Of special importance in this context is the fact that it is on the membrane surface that many of the processes determining the cell function take place [16]. In particular, membranes influence the enzymatic activity and coordinate the chemical reactions inside the cells. Membranes also take part in intercellular coordination - the transmission of information from one cell to another on contact, as well as in intracellular communications. The intermembrane contact itself can result from active motions of membranes associated with the vibrations excited in them. In their capacity of a coordinator of intracellular activity and intercellular interactions, membranes are in a continuous state of motion and change. This is probably how the informational effects of EMR are produced: by affecting the patterns of acoustoelectrical oscillations in the membrane, the radiation can regulate the processes in the cells; through processes at the cellular level, it can affect the functioning of complex multicellular organisms. The targets of regulation would

Approved For Release 2000/08/08 : CIA-RDP96-00789R003100280001-7

include the membrane transport [7], the reactions, and the existence of plane connections. This is independent on the initial reciprocal positions of the membranes and the transmission of vibrations from one of the communicating membranes to the other; this process would be affected not only by the type of contact but by the distribution of the fields as well.

Judging by the morphological descriptions of temporary changes in the cells exposed to unfavorable impacts, the so-called endoplasmatic network (a system of interlinked deformed membrane elements) and deformations of this network can be an important factor in controlling the processes aimed at recovering normal vital functions.

A detailed description of the processes is still beyond the grasp of investigators, but their vital importance for the cell and the organism is unquestionable.

In short, the features and regularities of the functioning of microwave devices, when applied to studies of the effects of electromagnetic vibrations on control processes in live organisms, can shed light on at least some of these processes. In particular, they provide a better understanding of the following:

- the influence of the oscillation frequency on these processes (the role of resonances in the form of oscillations induced in the membranes);
- the limited influence of further increases of the EMR power on these processes (since they occur as synchronization of membrane oscillations rather than by power impacts on cellular processes) once the power is above a certain threshold;
- the reasons for the pronounced effectiveness of radiation in organisms with disrupted function (which develop structures to connect membrane oscillations with external radiation); and
- the need for long-term irradiation to obtain a residual biological effect (this concerns restructuring in the cells, which consumes energy and requires material to be brought to the site of action in the course of metabolic processes).

A single study can make only a limited contribution to understanding these exceedingly complex and little-investigated processes, which emphasizes the importance of continuing this research.

REFERENCES

1. N. D. Devyatkov, M. B. Golant, and T. B. Rebrova, "Radioelectronics and medicine (the possible uses of analogies)," *Izv. VUZ. Radioelektronika**, vol. 25, no. 9, pp. 3-8, 1982.
2. N. D. Devyatkov, "The influence of electromagnetic radiation in the millimeter wave band on biological objects," *Uspekhi Fiz. Nauk*, vol. 110, no. 3, pp. 453-454, 1973.
3. N. D. Devyatkov, E. A. Gelvich, and M. B. Golant, et al., "Radiophysical aspects of medical applications of energy and information effects of electromagnetic vibrations," *Elektron. Tekhnika, Ser. Elektronika SVCh*, no. 9 (333), pp. 43-50, 1981.
4. N. D. Devyatkov and M. B. Golant, "The informational nature of nonthermal and energy effects of electromagnetic vibrations in a live organism," *Pis'ma v Zh. Tekhn. Fiz.*, vol. 8, no. 1, pp. 39-41.
5. A. K. Bryukhova, M. B. Golant, and T. B. Rebrova, "Reproducibility of experimental results in studies of the effects of electromagnetic radiation of a nonthermal intensity in the millimeter wave band as affecting live organisms," *Elektron. Tekhnika, Ser. Elektronika SVCh*, no. 8, pp. 52-57, 1985.
6. H. Frolich, "The biological effects of microwaves and related questions," *Advances in Electronics and Electron Physics*, vol. 11, pp. 85-132, 1983.
7. N. D. Devyatkov, M. B. Golant, and A. S. Tager, "The role of synchronization in the effects of weak millimeter wave band electromagnetic signals on live organisms," *Biofizika*, vol. 28, no. 5, pp. 895-896, 1983.
8. R. L. Vilenskaya, E. A. Gelvich, and M. B. Golant, et al., "The nature of the influence of millimeter radiation on colicin synthesis," *Nauchnye Doklady Vysshei Shkoly, Biologicheskie Nauki*, no. 7, pp. 69-71, 1972.

*Radioelectronics and Communications Systems. Available from Allerton Press, Inc., 150 Fifth Ave., New York, N. Y. 10011; (212) 924-3950.

9. "Promising research and methods for medicine and biology," *Elektronnaya Promyshlennost*, no. 1 (139), pp. 6-13, 1985.
10. E. N. Balibalova, A. G. Borodkina, and M. B. Golant, et al., "Amplitude modulation used to improve the efficacy of equipment utilized for informational influence of electromagnetic vibrations on live organisms," *Elektron. Tekhnika, Ser. Elektronika SVCh*, no. 8 (344), pp. 6-7, 1982.
11. M. B. Golant and V. A. Shashlov, "The mechanism of vibrations induced in cell membranes by weak electromagnetic fields," in: *Applications of Electromagnetic Low-Intensity Radiation in Biology and Medicine* [in Russian], N. D. Devyatkov (Editor), IRE AN SSSR, Moscow, pp. 127-132, 1985.
12. W. Grundler and F. Keilmann, "Sharp resonances in yeast growth prove nonthermal sensitivity to microwaves," *Physical Review Let.*, vol. 51, no. 13, pp. 1214-1216, 1983.
13. L. A. Sevast'yanova, A. G. Borodkina, E. S. Zubenkova, et al., "Resonance nature of the millimeter radiowave effects on biological systems," in: *Nonthermal Effects of Millimeter Radiation on Biological Objects* [in Russian], IRE AN SSSR, Moscow, pp. 34-47, 1983.
14. V. G. Ivkov and G. N. Berestovskii, *Lipid Bilayer of Biological Membranes* [in Russian], Nauka, Moscow, 1982.
15. G. Stant and R. Calindar, *Molecular Genetics* [Russian translation], Mir, Moscow, 1981.
16. L. D. Bergel'son, *Membranes, Molecules, Cells* [in Russian], Nauka, Moscow, 1982.
17. M. B. Golant, A. K. Bryukhova, and E. A. Dvadtsova, et al., "The possibility of regulating the vital activities of microorganisms exposed to electromagnetic vibrations in the millimeter band," *Applications of Electromagnetic Low-Intensity Radiation in Biology and Medicine* [in Russian], N. D. Devyatkov (Editor), IRE AN SSSR, Moscow, pp. 115-122, 1983.
18. S. J. Webb, "Nutrition, coherent oscillations, and solitary waves: The control of in vivo events in time and space and its relationship to disease," *IRCS Med. Sci.*, vol. 11, pp. 483-488, 1983.
19. I. V. Lebedev, *Microwave Technology and Devices* [in Russian], Vysshaya Shkola, vol. 2, 1972.
20. O. S. Sotnikov, *Structural Dynamics of a Live Neuron* [in Russian], Nauka, Leningrad, 1985.
21. S. Roulands, "Coherent excitations in blood," in: *Coherent Excitations in Biological Systems*, Springer Verlag, Berlin-Heidelberg, pp. 145-161, 1983.
22. N. D. Devyatkov and M. B. Golant, "The mechanisms of action of millimeter-band electromagnetic radiation of nonthermal intensity on the vital activities of organisms," in: *Applications of Electromagnetic Low-Intensity Radiation in Biology and Medicine* [in Russian], N. D. Devyatkov (Editor), IRE AN SSSR, Moscow, pp. 18-33, 1983.
23. E. Del Giudice, E. Doglia, and M. Milani, "Self-focusing and ponderomotive forces of coherent electric waves: A mechanism for cytoskeleton formation and dynamics," in: *Coherent Excitations in Biological Systems*, Springer-Verlag, Berlin-Heidelberg, pp. 123-127, 1983.

13 January 1986

RADIOELECTRONICS AND MEDICINE (ON SCOPE FOR USING CERTAIN ANALOGIES)

N. D. Devyatkov, M. B. Golant, and T. B. Rebrova

Izvestiya VUZ. Radioelektronika,
Vol. 25, No. 9, pp. 3-8, 1982

UDC 621.38:61

Large radio-electronic systems and living organisms are both complex systems (albeit of very different degrees of complexity), and a great role is played by informational aspects in ensuring their long-term uninterrupted operation. Since radio-electronic systems are incomparably simpler than living organisms, the ways of studying them and ensuring their reliable operation are vastly simpler. It is suggested that, on the basis of analogies, the approach to the solution of medical-biological problems can in certain cases be simplified.

With the wide use of radio-electronics and cybernetics it has become possible to create a new apparatus playing a revolutionary role in modern medicine and biology. The range of application of the new apparatus is so vast that it can scarcely be surveyed in a single article. Nevertheless, there is one link between these sciences that is only just starting to be developed, though it may well prove very fruitful in the future. We are speaking of the possibility of using in medicine and biology certain general ideas of electronics and cybernetics, and on the basis of analogies, devising new approaches to the solution of medical-biological problems. But let us emphasize at the outset that only a few aspects of this vast and many-sided topic can be mentioned here.

Radio-electronics is concerned at present with devising complex multielement systems suitable for long-term uninterrupted operation in varying external conditions. Living organisms (primarily men) are likewise complex systems (though much more complex), often with a very long life. This means from the physical point of view that the ordering and organization of the systems have to be preserved or restored while in contact with the external medium, and that their entropy (a measure of their lack of order) has to increase extremely slowly [1]. We need to consider the main conditions for long-term preservation of the ordering of a large system. In principle, the following conditions refer, not only to electronic systems and living organisms, but also to any large stably operating systems, such as e.g., undertakings with external connections:

- a) we need a material and energy supply from outside for the system, to make good its energy consumption and to replace elements that have ceased to perform their function;
- b) we need reserves such that, on the one hand, partially failed elements can be kept at the operating level needed for maintaining operation of the system as a whole, and on the other hand, so that reserves of certain elements can be mobilized in order to compensate for poor operation of others;
- c) we need circuits for obtaining and transmitting data about all variations inside and outside the system, so that the system can adequately respond to these variations;
- d) we need central and peripheral control circuits, and automatic feedback loops for controlling the system response to internal and external variations;
- e) we need a sensitive display whereby processes unfavorable to the system can be detected in their early development stage and the data obtained used for adjusting the system, so as either to stop the further development of these processes or to prepare the system for operation in the new conditions.

The approach to the living organism as a unified, data-connected and data-controlled system, implies the first importance of data aspects when solving medical and biological problems. While this is obvious in principle, the ways of going over from general ideas

to practice. It is clear by no means clear in medicine and biology, as they are, comparatively speaking, in electronics: many unsolved or only partially solved problems still need to be studied. We need to know how the data systems of the organism operate, what sort of scope they have, and how medical interference can assist the operation of the data systems, etc.

To the extent to which the data signals in the organism are electrical (The data system is not solely concerned with electrical signals. In particular, an important role is played by data transmission by humoral agents. But we shall only deal here with electromagnetic oscillations.) and the problems concern the "electronic" properties of the living organism, the ways of studying the problems must also be "electronic," i.e., they must involve a study of spectral characteristics, and of nonlinear and modulation properties etc. An important step forward was made in [2] with the proof (based on analysis of many experimental data) of some basic laws governing the interaction of low-power electromagnetic oscillations (EMO) with living organisms. The two main laws are:

a) weak dependence of biological effects of external (radiation-connected) data signals on the EMO power flux, starting from a (usually extremely low threshold level and going up to levels at which effects connected with heating of the irradiated object start to have an important role;

b) the sharply resonant response of living organisms to low-power EMO radiation (We are only speaking here of signal frequencies at which the energy of the quanta is insufficient for disrupting the molecular bonds.); the relative frequency bandwidth in which a response is seen usually does not exceed tenths of one percent; often a number of mutually displaced bands is observed, in which the biological object has a similar response.

The nature of these laws has been discussed in various Russian and foreign publications, e.g., [3, 4, 5]. In particular, it was suggested in [3, 5], on the basis of a comparison with technical cybernetic systems, that the first law is linked with the informational nature of the weak EMO signal action on the living organism and is determined by the reliability of operation of the organism data system.

On the other hand, information on the state and operation of the different organs and systems of the organism is contained in the spectrum of the signals generated by the organism; to each variation of the state or type of activity there correspond specific spectrum variations. The spectrum extends from very low to (at least in some cases) ultraviolet frequencies [11]. A special role is played by the lines in the infrared part of the spectrum, i.e., in the vicinity of the maximum of thermal radiation at the organism temperature. This is confirmed by the determination and analysis of Raman spectra [6, 7] of living organisms, which include a number of pronounced lines in the infrared part, and also their harmonics and combination frequencies. In [4], the author summarizes many years of theoretical study, and gives a detailed justification of the hypothesis that the direct action of low-power EMO on the living organism is linked with collective excitations of certain structural elements of the organism (Both the author of [4] and many other foreign or Russian authors assign a big role in the perception of excitations to cellular membranes.); the quasi-particles characterizing these excitations behave like Bosons, i.e., are subject to Bose statistics.

The threshold power needed for response to irradiation is determined by the transition from excitation of noise oscillations to excitation of coherent high-amplitude oscillations at a mode of collective excitation. The presence of this kind of excitation remote from absolute zero [8] in the living organism becomes possible as a result of material exchange and energy transformation, whereby, in the neighborhood of certain frequencies, energy loss in the data transmission system and data signal processing system can be compensated. But, as was earlier pointed out in [1], in conditions of compensation of energy loss by the source, any system can behave like a system operating in the neighborhood of absolute zero.

Notice also, see [9], where action of frequency-modulated low power EMO signals on the living organism was studied, that the frequencies at which a response to weak signal radiation is seen, can differ slightly (by approx. 0.001 of the basic frequency) according to the irradiated part of the body. It was also shown that the bandwidth (likewise 0.001 of the basic frequency) in which the organism responds to irradiation, is determined by the presence of several oscillators with displaced frequencies, and hence low-amplitude frequency modulated irradiation can lead to some increase in the organism response.

These and other experimental and theoretical studies have somewhat clarified the ways possible for medical interference in the operation of the data systems of an organism. The

(usually low-level) signals functioning through the data systems of the organism are called data signals [3, 5]. It is natural to ask what the function of these signals is. A general answer might be as follows: to mobilize the reserves of the organism when, for some reason, the normally functioning data system cannot perform this task itself. (Data have so far been published only on certain data EMO signals and the nature of their mobilizing action on the organism. The experimental data refer mainly to protective action of EMO on hemopoiesis, action on malignant neoplasms, ophthalmological diseases, trauma, and certain heart-vascular diseases etc. But we can in principle expect that, as research widens, the range of these signals will be extended and the scope for mobilizing the reserves of the organism will correspondingly be seen to increase.) This is to some extent similar to adjustment of the feedback loops of an electronic system in order better to mobilize the reserves built into the system.

This answer can appear unassuming at first sight: we merely use the signals so that the organism fully performs its functions, admittedly, in varying conditions. But it has to be borne in mind, first, that the prime task of medical interference is to restore the organism to its normal state. Second, any of the present popular medical facilities are precisely aimed at assisting the organism in its struggle with illness, and not at its substitution, so that, from this point of view, the data signals present no exceptions. Third, and most important, the vast reserve potentials of the organism have to be borne in mind. By gradual training a man can be taught to withstand cold, heat, oxygen deficiency in mountains, to consume a small amount of food and moisture, to maintain large physical loads, to accelerate regenerative action, etc. To realize these possibilities, slow adjustment of the organism is needed, specially of its system of internal feedbacks. (We are speaking here of gradual adjustment in connection with changes in conditions of existence, though it has to be remembered that similar adjustments can be caused by psychological attitudes (also long-term). For instance, there are the widely known "self-adjustments" of logov to long-term oxygen deficiency, or to enormous static loads reaching several tons, etc.). But medicine is often concerned with cases when sudden disruptions do not leave time for slow adaptation and adjustment of the organism, and its reserves cannot be brought into action in natural conditions. This is sensible starting-point for using data signals, whereby the adjustment of the organism can be accelerated many times. In [5], from analysis of examples of EMO data signals remembered by the organism, it is concluded that the organism mobilizes them for overcoming factors unfavorable to its operation. Naturally, the data signals can also prove useful when the data communication circuits are destroyed and external signals are used for replacing those that do not arrive over the natural channels.

Discovery of the effects of data signals on adjustment of the organism can be assisted by experiments in which the organism is irradiated by square pulse amplitude-modulated EMO signals [10]. Even earlier, in [2, 5], it was established that often, when data stimulation is realized by continuous EMO, fairly long-term (not less than an hour in [2, 5]) irradiation is needed. In [10] the biological results of stimulation were compared for two types of irradiation. The first type was continuous, using a generator with power only 20-30% above the threshold required for obtaining a biological effect, so that any significant power reduction or reduction of irradiation time to under 45 mins, leads to vanishing of the effect. The second was the square pulse amplitude-modulated mode of the same generator; pulse duration was $1.6 \cdot 10^{-3}$ sec, repetition period was 0.01 sec, and pulse power was equal to the power in the first (continuous) mode. It was found that the biological effect is virtually the same for an hour's irradiation in either mode. This shows that the living organism requires a short time (at most 10^{-3} sec) for response to irradiation, whereas relaxation from the stimulated state requires over 0.01 sec. As a result, the pulse and continuous modes give the same biological effect. Relatively long-term irradiation is needed for certain systems of the organism to adjust, thereby producing a memory of the stimulus.

With continuously varying conditions of existence, and with breaks of the data connections, the organism has to adjust itself continuously, often quite rapidly in the cases where medicine is concerned. It can therefore be expected that there will be increased use of data EMO stimuli in medicine as research progresses (It may be mentioned incidentally that the organism usually becomes accustomed to any medical stimuli, presumably due to its adaptability to any external factors demanding adjustment of its operation. But so far, no adaptation to data EMO stimuli has been observed. This is possibly because data communication is realized in the organism by similar signals, and the organism adapts to them simply by "not noticing" them.)

Let us touch on the last of the above-mentioned conditions for long-term uninterrupted operation of a large system, namely, the presence of circuits for obtaining information about all the changes affecting the system operation. By obtaining information about faults

that are just starting, before they have had time to effect the operation of an electronic system, we can take measures (such as replacing certain units or adjusting the system, etc.) in good time and thereby avoid failure of the system operation. Hence more and more attention is being paid to ways of obtaining such early information when designing high-reliability systems.

In the same way, early diagnosis is well known to simplify the treatment of sick people. Disease is usually first indicated by painful sensations, the living organism being equipped with a data system unique in its universality for supplying data on the presence of disease. Yet there are times when the organism starts to perceive signs of disease too late (e.g., in the case of appearance of malignant neoplasms), in which cases cure becomes more difficult. For various reasons, prophylactic inspections only partially fill this gap. But it can be predicted that, with further study and development of EMO data stimuli, we shall be able to use the organism's data system itself for early diagnosis, as a result of increasing its sensitivity short-term.

It should be mentioned in conclusion that the problems of ensuring long-term uninterrupted operation of a large complex system, regardless of its nature or function, have several common aspects, notably informational. Modern complex electronic systems, like living organisms, belong to the class of large systems. It has therefore been premised above that, in spite of a vast difference in their degrees of complexity, there can be obvious analogies in the approach to the study and furnishing of conditions for reliable operation, of these systems. For the simpler and more readily inspected electronic systems, the solutions of many problems can be found more easily. By analogy, such solutions can contribute to new approaches to medical-biological problems. This should be a further trend in the penetration of radio-electronics into medicine.

REFERENCES

1. E. Shroedinger, What Life is from the Point of View of Physics [in Russian], Atomizdat, Moscow, 1972.
2. Scientific session of general physics and astronomy section of Academy of Sciences, USSR (17-18 Jan. 1973), UFN, G110, no. 3, pp. 452-469, July, 1973.
3. N. D. Devyatkov and M. B. Golant, "On the informational nature of non-thermal and some energy stimuli of electromagnetic oscillations on the living organism," Letter to ZHTF, no. 1, 1982.
4. H. Frolich, Advances in Electronics and Electron Physics, vol. 65, pp. 85-110; 148-152, 1980.
5. N. D. Devyatkov et al., "Physical aspects of the medical use of energy and informational electromagnetic stimuli," Elektronnaya tekhnika, Seriya Elektronika SVCh, no. 9 (333), 43-50, 1981.
6. S. Webb, Phys. Pep., no. 60, p. 201, 1980.
7. E. Del Gindice, S. Deglia, and M. Milani, Phys. Lett., Oct., vol. 15A, no. 6,7, pp. 402-404, 1981.
8. L. Landau and E. Livshits, Statistical Physics [in Russian], GITTL Press, Moscow, 1951.
9. L. Z. Balakireva et al., "Study of influence of FM radio waves on protection of marrow-bone hemopoiesis of living animals subject to X-ray irradiation," Elektronnaya tekhnika, Seriya Elektronika SVCh, no. 8, 1981.
10. E. N. Balibova, A. G. Borodkina, M. B. Golant, T. B. Rebrova and L. A. Sevast'-yanova, "Using amplitude modulation to increase the working efficiency of the devices of informational stimuli of electromagnetic oscillations on living organism," Elektronnaya tekhnika, Seriya Elektronika SVCh, no. 8, 1981.
11. V. P. Kaznacheev and P. P. Mikhailova, Very Weak Radiations [in Russian], Nauka Press, Moscow, 1981.

5 April 1982

Contents

VOLUME 25

NUMBER 9

1982

	PAGES	
	RUSSIAN/ENGLISH	
Radioelectronics and medicine (on scope for using certain analogies). N. D. Devyatkov, M. B. Golant, and T. B. Rebrova.....	3	1
Adaptive quasi-coherent digital signal demodulators for fading channels. N. N. Belousov and V. E. Martirosov.....	8	5
Adaptive algorithm for detection of narrow-band signals in noise of un- known power and spectral shape. V. P. Peshkov.....	14	10
Use of redundant coding in channels with variable parameters. B. I. Filippov.....	20	16
High-speed digital filters with serial processing of data places. L. M. Osinskiy and O. V. Glushko.....	25	20
Determination of characteristic function and Poisson spectrum of gen- erating process jumps from characteristic function of linear system response. B. G. Marchenko and L. D. Protsenko.....	31	26
Quantization errors in adaptive antenna arrays. I. V. Grubrin, O. I. Zaroshchinskii, and V. I. Samoilenko.....	38	33
Detection of radio signals reflected from extended statistically rough surface. V. I. Chizhov.....	43	38
Transformation of equations of state variables for circuits with strict numerical degeneracies. Yu. M. Kalnikbolotskii and V. V. Khilenko...	47	43
Analysis of control voltage overshoots in load network in FET analog switches. G. F. Zverev, D. F. Zaitsev, V. A. Radchenko, and Ya. L. Khlyavich.....	52	48
Equivalent circuit of physical processes in semiconductor structures for large signal mode. V. P. Voinov.....	56	52
Characteristics of spectrum analyzer of recirculation type using charge transport devices. I. A. Balyakin, Yu. M. Egorov, and V. A. Rodzivilov.....	59	55
Noise immunity of standard frequency discriminator with rejection of anomalous errors in fluctuation noise conditions. A. F. Fomin, L. M. Zhuravleva, and V. S. Kostroma.....	64	60
<u>Brief Communications</u>		
Use of a priori information on structure of correlation matrices for adaptation. V. M. Koshevoi.....	71	65
Digital processing of narrow-band signal characteristics. A. V. Zhogal and Yu. L. Svalov.....	73	68 ✓
Estimation of noise immunity of redundant coded system with pseudo- random switching of frequencies. V. A. Lyudvig and A. M. Chudnov...	75	70
Bandwidth of tapped delay line noise compensator. B. V. Nikitchenko and V. V. Popovskii.....	77	73
Smoothing of trajectory measurement data by polynomials of variable order. N. D. Ogorodnichuk.....	79	76
Measurement of parameters of motion by comparing structures of wave fronts. V. A. Chulyukov.....	82	80
Adaptive compensation of nonlinear distortion when using compensation channel with cubic response. M. G. Kolesnik, S. V. Nikitin, and V. V. Nikitchenko.....	84	83
Matched filter using main maximum of signal for estimating instant of arrival. N. A. Dolinin.....	86	85
Information criteria for estimating performance of image receivers. B. O. Karapetyan.....	88	88

(continued)

TAB

The growth rate of the plants in height was measured. The dynamics of the change in the growth rate distribution function of the plants was analysed for 30 days from the start of signs of germination.

At the initial moments of time of growth (5-7 days after sowing) the growth rate distribution of the plants was close to a normal one. However, on days 10-12 after sowing this function completely "collapsed" (Fig. 1) but after a further 3-4 days growth it regained its normal form. Change in the external conditions (air temperature, luminosity) only shifted the moment of onset of "chaos" in line with the phase shift of development of the plant. Nor was there any change in the character of the "collapse" with the different density of sowing: the growth rate of each individual plant fluctuates.

Study of the consumption of nutrients in the seeds and accumulation of the dry biomass in the plant leaves shows that the moment of "chaos" coincides with the moment of passage of the plant from the heterotrophic to the autotrophic type of nutrition. At this moment a minimum of dry matter is observed in the plant (plant mass plus seed mass) (Fig. 2). This allowed us to assume that the effect of variability in the growth rate of the plants may be explained on the basis of the trigger model of Chernavskii *et al.* [1] in which "chaos" corresponds to the bifurcation state on parametric switching of the genetic system by the Jacob-Monod scheme. Change in the parameter of the system is achieved by changing the supply of substrate. The bifurcation state is interpreted as the moment of the onset of competence for differentiation [1]. Apparently the above described phenomenon of variability of plant growth in terms of the speed parameter is experimental confirmation of the general theorem of Chernavskii that the advent of new forms must necessarily proceed through the state of chaos. Variability is the necessary payment for development and complication [2].

REFERENCES

1. CHERNAVSKII, D. S. *et al.*, Oscillatory Processes in Biological and Chemical Systems (in Russian) p. 138, Nauka, Moscow, 1982
2. BYELOUSOV, L. V. *et al.*, Ontogenez 16: 213, 1985

Biofizika Vol. 33 No. 5, pp. 961-964, 1988
Printed in Poland

0006-3509/88 \$10.00+.00
© 1989 Pergamon Press plc

ACOUSTIC DETECTION OF THE ABSORPTION OF ELECTROMAGNETIC RADIATION OF THE MILLIMETRE RANGE IN BIOLOGICAL OBJECTS*

I. G. POLNIKOV and A. V. PUTVINSKII

Institute of Radioengineering and Electronics, U.S.S.R. Academy of Sciences, Moscow

(Received 2 September 1987)

ON irradiation of various biological preparations, cells or intact organisms, with millimetre (mm) waves a whole series of effects is observed already successfully used in medicine [1-3]. Many authors have observed marked frequency-dependence of the effects on the basis of which the possibility of the non-thermal resonance interaction of k.h.f. radiation with living systems is discussed [1, 4].

* Biofizika 33: No. 5, 893-894, 1988.

Acta 593: 427, 1980
32

0006-3509/88
© 1989 Pergamon

PLANT GROWTH

3. SMIRNOVA

Sciences, Kishinev

rch 1987)

a different temperature
growth rate distribution
artificial climate inst
re investigated: 200
25°C. Volume of the

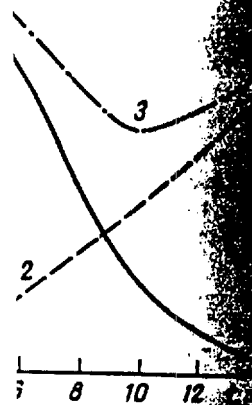
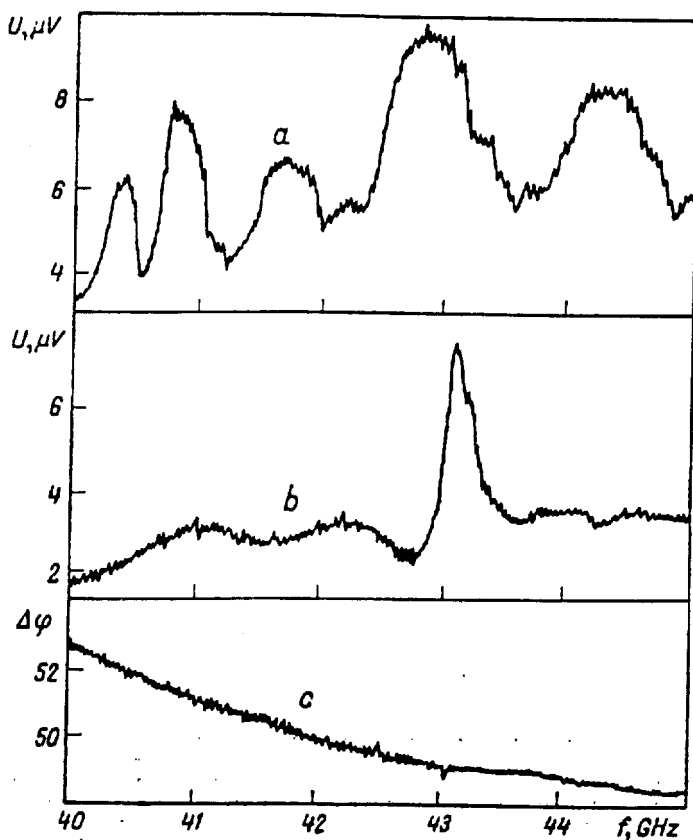

FIG. 2
temperature 20°C,
sowing.
biomass of leaves

Obviously to solve the problem of the mechanisms of the biological action of mm waves the first need is to establish whether the frequency dependence of absorption of energy of this radiation exists in bio-objects. In the present work to control absorption it is proposed that the method of acoustic detection of absorbed power (a.d.a.p.) is used — based on recording the thermo-elastic vibrations induced by absorption of modulated radiation. Such measurements have already been practically mastered in the optical range (photo-acoustic spectroscopy) [5]. It is interesting to note that the phenomenon of thermoelastic transformation of the radiation to sound itself is also known in electromagnetic biology: on absorption of the pulses of a u.h.f. field in the tissues of the head the human subject hears so-called "radio sound" [6].



Frequency dependence of absorption of the energy of modulated mm emission impinging on: *a*—rectangular quartz cuvette (1 mm thick) filled with water and positioned in the near zone of the horn (U is the signal of the piezo detector at the rear wall of the cuvette); *b*—polyethylene capillary (internal diameter 0.7 mm) with water passing through the waveguide (U is the signal of the microphone inserted into the capillary at a distance 1 cm from the waveguide); *c*—is the skin of the human hand (between the horn and the skin is a well harmonizing fluoroplast gas microphone cell: $\Delta\phi$ is the phase shift between the modulating and acoustic signals).

The experimental apparatus was assembled on the basis of a LOV-55 with the k.h.f. circuit ($5.2 \times 2.6 \text{ mm}^2$) and included the necessary instruments for controlling and stabilizing the radiation power and frequency (35–53 GHz), low frequency modulation (2–1000 Hz) using *P-i-N*-diodes on the LOV grid. The rate of the sweep of the radiation frequency, 1–10. MHz/min. The recording part

of piezoceramic UPI-2 synchronous two-coordinate automaton. The thermoelastic vibrations of the air layer next to the horn emitters are most pronounced. It is shown that in this case the object is in the near zone of the horn. The dependence of the harmonic content of the signal in the near zone of the horn on the frequency of the radiation is shown. The method of detection of artefacts in the signal is described. It is shown that, that is, on detection of the signal to irradiate the solution. The signal produced into the waveguide. At the main frequency the maximum signal can also be observed in this case. The main mode to other

of the irradiated object is the frequency dependence of the signal. It is possible. Is the frequency dependence of the signal with this on irradiation of the frequency dependence of the signal in human skin since, in principle, can be used for thermodynamic checking to detect changes in wavelength of the phase difference of the phase difference by the time of detection. It was found that the results are as in the Fig. 1. The frequency of mm emission is the frequency of mm waves. The frequency of special interest is the frequency of its complex. The control of the frequency of the detection spectra of the horn emitters are grateful

Non-Thermal Effects of Millimeter Waves (Deryatkov) 220
 Millimetre Low Intensity Radiation (IRE Akad. Sci. USSR, Ye. A. et al., 1983)
 Excitations in Biological Systems (S. Berg, 1983)
 Adv. Sci. Ser. A, Adv. Sci. Ser. A, Adv. Sci. Ser. A

action of
f energy of
posed that
the thermo-
ave already
interesting to
f is also know
s of the head



f, GHz

emission imping
d in the near zone
b - polyethylene
s the signal of the
- is the skin of the
microphone cell;
als).

55 with the k.h.f.
l stabilizing the r
(z) using P-I-N-di
/min. The record

consisted of piezoceramic detectors, condenser microphones, narrow band electrically tuned filters and a UPI-2 synchronous quadrature detector. The amplitude of the acoustic signal was recorded on a two-coordinate automatic recorder.

The thermoelectric vibrations on absorption of mm radiation are generated in the object itself and in the air layer next to the absorbing surface. In both cases the amplitude of the acoustic signal is proportional to the absorbed power of radiation [5]. We used both variants of a.d.a.p.

Horn emitters are most often used to irradiate biological objects with mm waves. Our experiments showed that in this case a marked pattern of the frequency dependence may be observed if the object is in the near zone of the horn (Figure, a). This curve with extremes points to the frequency dependence of the harmonization of the k.h.f. circuit with the object based on the multimode interference in the near zone of the horn. It is important to note that the phenomenon discussed is not expressed in the frequency dependence of the power reflected in the circuit and, therefore, may be the cause of artefacts in the evaluation based on waveguide measurements of the radiation absorbed in the object, that is, on detection of the action spectra.

To irradiate the solutions or cell suspensions a different method was sometimes used: a capillary was introduced into the waveguide through non-emitting apertures. According to the a.d.a.p. data at a certain frequency the maximum release of k.h.f. power in the capillary with an aqueous medium may also be observed in this case (Figure, b). This effect described in [7] is due to the transformation of the main mode to other types of waves and may be noted during careful measurements in the circuit.

If the irradiated object is a layered structure then as shown by theoretical analysis [8] unevenness and the frequency dependence of the release of k.h.f. power over the layers as a result of interference effects are possible. Is the frequency dependence of the action of mm radiation on the human body not linked with this on irradiation of reflexogenic zones? The a.d.a.p. method makes it possible to investigate the frequency dependence of the depth of penetration and the absorption profile of the mm waves in human skin since the dependence of the acoustic response on the modulation frequency of emission, in principle, carries full information on the field distribution pattern in the skin (if, of course, its thermodynamic characteristics are known).

In seeking to detect changes in the depth of penetration of mm emission into the human skin with change in wavelength we simply recorded by the gas microphone method the frequency dependence of the phase difference of the modulating and acoustic signals. Evidently this parameter is determined by the time of diffusion of heat to the skin surface and is greater the deeper the radiation penetrates. It was found that in conditions of careful harmonization of the horn with the skin (when the effects as in the Figure, a, are excluded) the phase shift monotonically drops with increase in the frequency of mm emission (Figure, c). This evidently simply reflects increase in the absorption coefficient of the mm waves in the skin, namely its aqueous component. In our view this fact indicates the absence of special features of the frequency dependence of absorption of mm emission in the skin due to its complex heterogeneous structure.

Thus, the control of the absorbed power by the a.d.a.p. method may serve for correct investigation of the action spectra of mm. waves in experiments *in vitro* and *in vivo*.

The authors are grateful to V. B. Sandomirskii for assistance in mastering the a.d.a.p. method.

REFERENCES

1. Effects of Non-Thermal Action of Millimetre Radiation on Biological Objects (in Russian) (Ed. N. D. Devyatkov) 220 pp., IRE Akad. Nauk SSSR, Moscow, 1983
2. Use of Millimetre Low Intensity Radiation in Biology and Medicine (in Russian) (Ed. D. N. Devyatkov) 284 pp., IRE Akad. Nauk SSSR, Moscow, 1985
3. ANDREYEV, Ye. A. *et al.*, Vestn. Akad. Nauk SSSR, No. 1, 24, 1985
4. Coherent Excitations in Biological Systems (Eds. H. Frölich and F. Kremer) Springer Verlag, Berlin-Heidelberg, 1983
5. ROSENCWAIG, A., Adv. Electronic and Electron Phys. 46: 207, 1976

6. CHOU, C. K. and GUY, A. W., *Biological Effects of Electromagnetic Waves* (Eds. C. Johnson and M. Shore) pp. 89-103, USNC/URSI Meeting, Boulder, Colorado, 1971
7. BYELYAKOV, Ye. V. *et al.*, *Summaries Reports Sixth All-Union Seminar: Use of Low Intensity MM Radiation in Biology and Medicine* (in Russian) p. 94, IRE Akad. Nauk SSSR, Moscow, 1986
8. RYAKOVSKAYA, M. L. *et al.*, *Dep. VINITI No. 801, 15 February 1983*

Biophysics Vol. 33 No. 5, pp. 964-975, 1988
 Printed in Poland

0006-3509/88 \$10.00+.00
 © 1989 Pergamon Press plc

POPULATION DYNAMICS OF PROLIFERATING CELLS ON PERIODIC PHASE-SPECIFIC EXPOSURE*

B. F. DIBROV, YE. V. GEL'FAND, A. M. ZHABOTINSKII,
 YU. A. NEIFAKH and M. P. ORLOVA

All-Union Research Institute of the Technology and Safety of Medicinals,
 Kupavna (Moscow Region)

(Received 4 June 1987)

The dynamics of the population size of proliferating cells on periodic exposure to phase-specific cytotoxic agents with a blocking and non-blocking action has been investigated theoretically. It is shown that for real values of the parameters of the model soon after the start of exposure the population size exponentially depends on time. The dependence of the dynamics of the population size on the integral parameters of the cell cycle and the regime of exposure has been studied. It is shown that in certain periods a resonance fall in the damage to the cells of the population must be observed. It has been established that the values of the periods corresponding to the resonance fall in damage are essentially determined by the mean duration of the cell cycle and the duration of the blocking action, for a short duration they are approximately a multiple of the mean duration of the cell cycle. Experimental study of the dependence of damage to the epithelium of the small intestine and the survival rate of mice on the period of repeated periodic injections of a S-phase specific cytotoxic agent - hydroxyurea - revealed a resonance increase in the survival of the mice and reduced damage to the epithelium on injections of this substance with periods close to the mean and double the mean duration of the cell cycle of the enterocytes of the crypts.

In antitumour chemotherapy and also in various experimental studies phase-specific preparations are widely used, i.e. preparations the action of which extends only to cells in a certain phase of the cell cycle. Earlier when investigating mathematical models we were able to show that on periodic introduction of high doses of phase-specific cytotoxics there may be resonance dependence of the survival of the proliferating cells on the interval between administrations with resonance maximum of survival at intervals close to (or a multiple of) the mean duration of the cell cycle [1]. In [1-4] it was shown that this effect may be used to optimize the phase-specific cytotoxic actions in the clinic and, in particular, in tumour chemotherapy.

* *Biofizika* 33: No. 5, 895-904, 1988.

TAB

DISSIPATIVE FUNCTIONS OF THE PROCESSES OF INTERACTION OF ELECTROMAGNETIC RADIATION WITH BIOLOGICAL OBJECTS*

YU. P. CHUKOVA

"Otklik" Time Scientific Collective (Kiev)

(Received 23 July 1987)

The authors have determined the rate of generation of entropy in biological systems as a result of the irreversibility of the processes of the interaction with electromagnetic radiation which one accompanied by rise in free energy. The characteristics of the irreversibility of the process of plant photosynthesis, human vision, etc. are presented. It is shown that in the processes considered, irreversibility may greatly differ (up to 10^6 fold).

IRREVERSIBILITY, as is known, is an integral property of all real processes. After the work of Prigogine [1] it is characterized by the magnitude S_i , called the rate of generation of entropy, the specific value of which σ is called a dissipative function. Among the variety of irreversible processes of the real world we would mention but a few (processes of heat and electrical conductivities, diffusion, thermal chemical reactions, etc.) for which methods of calculating this magnitude have been devised. As for biological objects for them as for more complex systems the question has hardly ever been raised. Yet, the achievements of the thermodynamics of irreversible processes in the last few years and, in particular, the successful application of the Landau-Vainshtein method for explaining the processes of energy transformation in quantum systems have made possible evaluation of the magnitude S_i for a large range of processes of interaction of electromagnetic radiation of any spectral composition with matter.

The method of determining S_i for endoergic processes occurring under the influence of electromagnetic radiation is outlined in [2]. It is applicable to open systems in the steady state. While in these conditions electromagnetic radiation with the energy W_a results in processes accompanied by rise in the free energy (endoergic processes) of the products (F_p) as compared with the free energy of the reactants (F_R) the efficiency of this process

$$\eta_e \equiv (\dot{F}_p - \dot{F}_R) / \dot{W}_a, \quad (1)$$

where the points above the magnitudes denote time derivatives. From the laws of thermodynamics for η_e we have the relation

$$\eta_e = 1 - T(\dot{S}_a + \dot{S}_i) / \dot{W}_a, \quad (2)$$

* Biofizika 34: No. 5, 898-900, 1989.

where \dot{S}_a is the flux of entropy of electromagnetic radiation with the power \dot{W}_a , which is absorbed by the system.

Usually relation (2) is analyzed in the approximation of the thermodynamic limit when $\dot{S}_i=0$ [3]. The limiting value of the efficiency of the system (η_e^*) may in this case be calculated for any system if the main characteristics of the process are known. \dot{S}_i may be evaluated from the difference of the real efficiency of the process (η_e) from the limiting.

The effects appearing in biological objects as a result of interaction with electromagnetic radiation and those magnitudes from which they are judged with rare exceptions cannot be interpreted as efficiency. But in threshold conditions when the bioresponse vanishes one may state that the efficiency of the endoergic process is equal to zero. This aspect is considered in detail in [2]. In threshold conditions of real efficiency we have

$$\dot{S}_i = \dot{W}_a^0 / T \dot{S}_a^0 - 1. \tag{3}$$

For the red boundary of all bio-effects with a wide frequency action band and for bioresonance effects the position of the zero efficiency boundary of the endoergic process in the approximation of the thermodynamic reversibility of the process is given by the relation

$$c^2 E_\nu^0 = 2\pi k T \nu^2 [(1 + \rho_0) \ln(1 + \rho_0) - \rho_0 \ln \rho_0], \tag{4}$$

where ν is frequency; E_ν^0 is the spectral density of the radiation at this frequency; T is the temperature of the system; c is the speed of light; k and h are Boltzmann and Planck constants; $\rho_0 = c^2 E_\nu^0 / 2\pi h \nu^3$.

The Figure illustrates this dependence for a wide frequency interval. The energy of electromagnetic radiation the characteristics of which (frequency and spectral density) enter the region *A* cannot be transformed to the free energy of the system even in the approximation of the thermodynamic limit (thermodynamic reversibility). The value E_ν^0 is always higher than the spectral density $\epsilon_{\nu, T}$ of the radiation of an absolute black

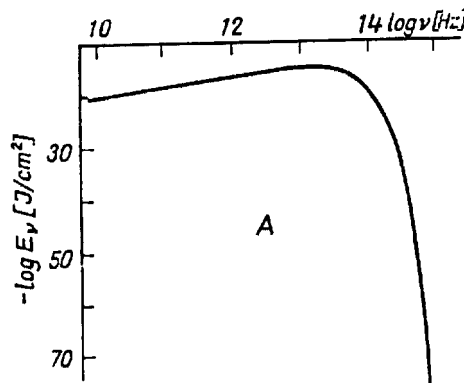

Position of zero boundary of endoergic processes on the plane $\log \nu - \log E_\nu$, in the approximation of the thermodynamic reversibility of the process.

Interactio

with the tempera
($h\nu \gg kT$): E_ν^0
position of the
dissipative pr
known from the e

system and process
and human vision a
boundary

synthesis of
mular algae
growing plants
growing plants
of λ prophage

rate of yeasts

of the haeme pro
in haemoglobin

The magnitud
other processes \dot{S}_i
ions and E_ν^0 is the c

would be reme
calculated sta
pose of the abso
the width of t
erred from the
gives the \dot{S}_i evalu

tion with biologic

processes and
is the range c

the evaluations
do not cause

existence of
Since the cha

of the effect th
may introduce t

shown in [2] to
dimensionless is

as it does by
stability exceeds

netic radiation

body with the temperature T . Their ratio $E_v^0/e_{v,T}$ assumes a simple form for high frequencies ($h\nu \gg kT$): $E_v^0/e_{v,T} = e$ and for low frequencies ($h\nu \ll kT$): $E_v^0/e_{v,T} = \ln(ep_0)$.

The position of the zero boundary of real processes is shifted towards high E_v values through dissipative processes. These processes may be evaluated from formula (3) if it is known from the experiment under which conditions the effect disappears.

System and process	Experimental conditions	\dot{S}_i or $S_i/\Delta\nu$	\dot{S}_i/\dot{S}_a
Threshold human vision at the red boundary	$\lambda = 780 \text{ nm}$, $E_v^0 = 3 \times 10^{-26} \text{ J/cm}^2$ [5]	3.6×10^{-29}	0.58
	$\lambda = 950 \text{ nm}$, $E_v^0 = 4 \times 10^{-20} \text{ J/cm}^2$ [6, 7]	6.7×10^{-23}	1.13
Photosynthesis of unicellular algae	$400 \text{ nm} < \lambda < 700 \text{ nm}$ [8]		
	$\dot{W}_a^0 = 5 \times 10^{-6} \text{ W/cm}^2$	1.2×10^{-8}	2.3
shade-loving plants	$\dot{W}_a^0 = 5 \times 10^{-5} \text{ W/cm}^2$	1.2×10^{-7}	2.6
light-loving plants	$\dot{W}_a^0 = 5 \times 10^{-4} \text{ W/cm}^2$	1.2×10^{-6}	3.1
Synthesis of λ prophage	$\nu = 70.4 \text{ GHz}$, $\Delta\nu = 0.6 \text{ GHz}$, $\dot{W}_a^0 = 10^{-4} \text{ W/cm}^2$ [9]	5×10^{-16}	6×10^4
Growth rate of yeasts	$\nu = 41.68 \text{ GHz}$, $\Delta\nu = 10 \text{ MHz}$, $\dot{W}_a^0 = 10^{-4} \text{ W/cm}^2$ [10]	3×10^{-14}	8×10^6
Rigidity of the haeme protein bond in haemoglobin	$\nu = 42.173 \text{ GHz}$, $\Delta\nu = 4.2 \text{ MHz}$, $\dot{W}_a^0 = 10^{-3} \text{ W/cm}^2$ [11]	7×10^{-13}	10^8

Note: The magnitude \dot{S}_i is measured in $\text{W/cm}^2 \cdot \text{K}$ for the processes of photosynthesis but for the other processes $\dot{S}_i/\Delta\nu$ is given in $\text{J/cm}^2 \cdot \text{K}$. \dot{W}_a^0 is the density of absorbed power in threshold conditions and E_v^0 is the corresponding spectral density of absorbed power $E_v^0 = \dot{W}_a^0/\Delta\nu$.

It should be remembered that to obtain correct evaluations of \dot{S}_i the \dot{S}_a values must be calculated starting not from the characteristics of the incident radiation but from those of the absorbed radiation if the width of the absorption spectrum is narrower than the width of the acting radiation. For the reverse ratio of bands \dot{S}_a must be considered from the spectrum of the elementary excitations in the system [4]. The Table gives the \dot{S}_i evaluations for a number of processes of interaction of electromagnetic radiation with biological objects.

The processes and systems included in the Table are so chosen as to demonstrate how wide is the range of values of the dissipative functions in different biological objects. It gives the evaluations of the dissipative functions both for processes the characteristics of which do not cause any doubt (human vision, plant photosynthesis) and for effects the very existence of which is of a debatable nature (bioresonance effects of u.h.f. radiation). Since the characteristics S_i and S_a essentially depend on the frequency characteristics of the effect then for the three last processes presented in the Table later experiments may introduce the most significant correctives.

As shown in [2] together with \dot{S}_i it is desirable to use the magnitude \dot{S}_i/\dot{S}_a which being dimensionless is a more graphic characteristic. Its physical meaning is simple showing as it does by how many times the rise in entropy as a result of thermodynamic irreversibility exceeds the rise in the entropy of the system through absorption of electromagnetic radiation and so characterizes the degree of perfection of the energy trans-

ducer considered. Perfect are those transducers in which the ratio \dot{S}_i/\dot{S}_a is low. The most perfect is the human eye especially in conditions of twilight vision ($S_i/S_a < 1$). In other systems $S_i/S_a > 1$ and for the processes of interaction of u.h.f. radiation with biological objects this ratio may reach 10^8 .

REFERENCES

1. PRIGOGINE, I., Introduction to the Thermodynamics of Irreversible Processes (in Russian) Inost. Lit., Moscow, 1960
2. CHUKOVA, Yu. P., Application of Low Intensity Millimetre Radiation in Biology and Medicine (in Russian) pp. 147-156, IRE, Akad. Nauk SSSR, Moscow, 1985
3. LANDSBERG, P. T. and TONGE, G., J. Appl. Phys. 50: R1, 1980
4. CHUKOVA, Yu. P., Zh. fiz. khim. 58: 42, 1984
5. MESHKOV, V. V., Bases of Light Technology (in Russian) Part 1, pp. 98, 336. Gosenergoizdat, Moscow-Leningrad, 1957
6. WALD, G., Science 101: 653, 1945
7. PINEGIN, N. I., Dokl. Akad. Nauk SSSR 56: 811, 1947
8. TARCHEVSKII, I. A., Fundamentals of Photosynthesis (in Russian) Kazan, 1971
9. WEBB, S. L., Phys. Lett. 73A: 145, 1979
10. GRUNDLER, W. *et al.*, *Ibid.* 62A: 463, 1977
11. DIDENKO, N. P. *et al.*, Effects of Non-Thermal Action of Millimetre Radiation on Biological Objects (in Russian) pp. 63-77, IRE, Akad. Nauk SSSR, Moscow, 1983

Biophysics Vol. 34, No. 5, pp. 978-982, 1989
Printed in Poland

0006-3509/89 \$10.00+.00
© 1991 Pergamon Press plc

REDUCTION OF THE PERMEABILITY OF ERYTHROCYTE MEMBRANES FOR OXYGEN DURING OXYGENATION*

M. V. FOK, A. R. ZARITSKII and G. A. PROKOPENKO

Lebedev Physics Institute, U.S.S.R. Academy of Sciences, Moscow

(Received 30 December 1987)

It is shown that during oxygenation of the blood the permeability of erythrocyte membranes for oxygen falls at least ten fold.

In [1] it was shown experimentally that on oxygenation in certain conditions of different volumes of donor blood the curves of the dependence of the degree of oxygenation α on the oxygenation time t in the coordinates α - $\log t$ may be combined with an accuracy $\pm 2\%$ by shifting along the $\log t$ axis. This means that the link between the degree of

* Biofizika 34: No. 5, 961-904, 1989.

Permeabi

and the rate of c
multiplier determini
differences n
apparently connecte
with the differenc

blood of one donor
each was oxygenate
the area of the free
by changing the leng
difference in the initia
at $27 \pm 0.5^\circ\text{C}$. T
oxygenating it
system glucose wa
which does not go i
to avoid coag
during prolonged w
which in all the blood

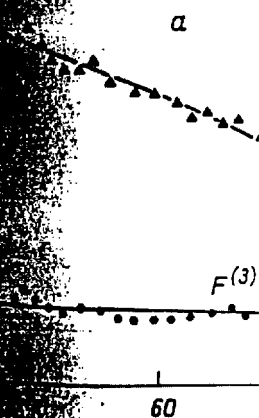

oxygenation rate v of the b
alpha for two (a) and t

indicates the depend
of their oxyg ena
rate decreased wit
to the state of oxyg
oxygenation rate was
of oxygenation the c
this situation appears